

Your **Experts** in Office Furniture

**Still No.1
after 40 years**

**All New Altura
Electric Workstation System**
See page 18-19

**9 HUGE
SHOWROOMS**
Try Before You Buy



**VIEW CATALOGUES
ONLINE** Visit:
empirefurniture.com.au/
catalogues

PROJECT SOLUTIONS IT'S EASIER WITH EMPIRE!

Our unique end to end solution results in expert fitouts for classrooms, libraries, admin offices & more!



Space planning



Project management



2D & 3D
visuals



Furniture
selection &
customisation



Delivery &
installation



Cable
management

**BUILT
STRONG
MOBILE
PEDESTAL**

FROM

\$189

MPBS2DF

SEE FULL DETAILS ON PAGE 34



**BUILT STRONG
TAMBOUR DOOR UNIT**

FROM

\$619

TDBS10H09W

SEE FULL DETAILS ON PAGES 36



Altura
SIT-STAND DESK

e1800 571 988
empirefurniture.com.au

- 2-3 Reception Counters
- 4-5 Lounge & Reception Seating
- 6-7 Boardroom & Meeting Tables
- 8-11 Shipshape Office Furniture
- 12-16 Citi System Furniture
- 17-19 Height Adjustable Electric Desks
- 20 Utility & Side Tables
- 21-25 Education Furniture & Whiteboards
- 26-28 Mesh & Operator Chairs
- 29-30 Executive & Boardroom Chairs
- 31 Foyer Chairs
- 32-33 Visitor & Breakout Chairs
- 34-36 Steel Storage & Lockers



Queensland Government
One of the Preferred Suppliers for QLD Government Furniture & Emergency School Furniture
Whole of Government SOA – QED 104526
Contact us for Approved Products List. www.empirefurniture.com.au/soa



New South Wales Government
Empire Office Furniture is an approved supplier for the NSW Government, under the Office and Education Furniture Contract No. 771. Empire is one of the "Tier 1" suppliers approved to fulfil orders up to and above \$150,000. Empire is approved to supply furniture from 12 product categories, across all NSW regions.

it's easier with
empire
office furniture

HILTON RECEPTION DESK

Minimalistic yet luxurious, our new designer reception range will captivate and impress at every glance. The unique "Ink-Line Groove" design creates the illusion of a timber batten look... the perfect finishing touch to a contemporary design.

- Image shown in Natural Oak and AbsoluteMatte® White melamine (also available in AbsoluteMatte® Black)
- Available in 50 melamine colours - please enquire
- 900D x 1100H

MADE TO ORDER
CUSTOMISE TO YOUR
DESIGN, SIZE OR COLOUR



FINGERPRINT RESISTANT HOB

The new AbsoluteMatte® finish in White or Black features advanced technology that delivers fingerprint resistance and antibacterial protection in a soft matte finish, perfect for high touch areas.

LENGTH	CODE
1800mm	HILTRC189
2100mm	HILTRC219
2400mm	HILTRC249
2700mm	HILTRC279
3000mm	HILTRC309

1800L STANDARD	1800L DELUXE
\$3709	\$4489
EXCLUDES INK-LINE & ABSOLUTE MATTE	INCLUDES INK-LINE & ABSOLUTE MATTE

Optional LED strip \$POA

RITZ RECEPTION DESK

**OPTIONAL
MARBLE LOOK
UPGRADE**



FROM
\$2239
EXCLUDES INK-LINE & MARBLE LOOK

- Image shown in Natural Oak Ink-Line and House Marble melamine \$2809
- Available in 50 melamine colours - please enquire
- 850D x 1100H

LENGTH	CODE
1800mm	RITZRC188
2100mm	RITZRC218
2400mm	RITZRC248



**SCAN TO
VIEW MORE
DESIGNER
RECEPTION
FURNITURE**



VEGA



ASTORIA



CONRAD



SWISH L SHAPE RECEPTION COUNTER



ONLY
\$1489
SAVE \$210
1850W x 1700D x 1160H
SWRC1816



- White with coloured feature panels
- Work surface 750mm deep (Return 600mm deep)
- Feature panel colours - select Charcoal or Brushed Silver

SWISH STRAIGHT RECEPTION COUNTER



ONLY
\$899
SAVE \$180
1800W x 750D x 1160H
SWRD1875



- White with coloured feature panels
- Work surface 750mm deep
- Feature panel colours - select Charcoal or Brushed Silver

SEMPLICE RECEPTION COUNTER



ONLY
\$2739
2400W x 950D x 1150H
SEMR249



- 500mm x 50mm scallop cutout in worktop for cable access
- Black or white melamine feature stand-off module
- Black or white aluminium feature strips
- High counter for privacy
- Available in Natural Oak/Black or Natural Oak/White

DRIFTWOOD RECEPTION COUNTER



ONLY
\$1439
2200W x 800D x 1150H
DRIFT01.BW



- Worktop 730H
- Driftwood Wrap Around Cowl With Feature Panel
- Adjustable Feet For Levelling
- Built in 3 Drawer Underdesk Pedestal + Built In CPU & Storage Cupboard
- 2 x Chrome Metal Cable Entry Covers With Brush Insulator

WELCOME RECEPTION



FROM
\$599
WELRC156



- Desk height 720mm
- 455mm clearance under hob
- 2 x cable holes
- 3 x decorative melamine panels on front



SIZE (mm)	CODE	PRICE
1554W x 645D	WELRC156	\$599
*1554W x 795D	WELRC157	\$599
1854W x 645D	WELRC186	\$599
*1854W x 795D	WELRC187	\$649

*Top/feature panel colours also available in Natural Oak (795D only)

- Base Colours in White or Ironstone
- Top/ Feature Panel Colours in Wild Oak or White



Sunrise & Benchmark Lounges

Ask about approved products

SOA QED
104526

SUNRISE MODULAR LOUNGE SYSTEM

- Many layout configurations available
- Stocked in new commercial grade fabric (Charcoal)
- Booth panels upholstered in designer quilted fabric.

ONLY
\$1389

SAVE \$386
SRISE015LBTA

BOOTHS FROM

\$819

SAVE 50%
SRISE01LB

As pictured
Double Booth with USB
\$1369
SRISE02LB

DUAL USB PORTS
\$POA



LOW-LINE COFFEE TABLE \$129
SRISECT0606 640W x 640D x 270H

Quilted Fabric Colours

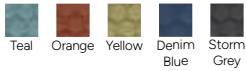

Flax Fabric Colours



Seat	No Arms - 750H x 750D			With Arms - 750H x 750D			Bench - 420H x 750D			Booth - 1400H x 750D			
	Length mm	Code	Price	Length mm	Code	Price	Length mm	Code	Price	Length mm	Code	Without USB	With USB
1	650	SRISE01L	\$519	890	SRISE01LA	\$839	650	SRISE01B	\$369	710	SRISE01LB	\$819*	\$839*
2	1300	SRISE02L	\$1109	1540	SRISE02LA	\$1429	1300	SRISE02B	\$809	1360	SRISE02LB	\$1329*	\$1369*
3	1950	SRISE03L	\$1499	2190	SRISE03LA	\$1819	1950	SRISE03B	\$1049	2010	SRISE03LB	\$1729*	\$1799*

Prices for Stocked Charcoal Fabric only. Extended Colour Range POA * Special prices on Booth Lounge Charcoal fabric seat and Storm fabric screens
* While stocks last

SCAN TO VIEW



RUN-OUT SPECIALS

BENCHMARK LOUNGE SYSTEM

- Stocked in commercial grade Black PVC
- Many other shapes available (indent \$POA)
- Also available in Flax fabric (indent \$POA)

VINYL COLOURS

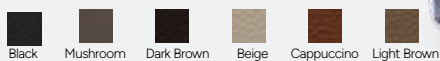

3 YEAR WARRANTY

SEAT	TYPE	DIMENSIONS (mm)	CODE	PRICE
1	Bench	420H x 775D x 760W	BMARK01B	\$429
1	Lounge	715H x 775D x 760W	BMARK01L	\$529
2	Lounge	715H x 775D x 1350W	BMARK02L	\$749
3	Lounge	715H x 775D x 2060W	BMARK03L	\$999



Reception Seating

RAINBOW SOFT-SEATING SYSTEM

MODULAR & MOBILE

- Smart design - 4 simple pieces
- Solid ply construction
- Heavy duty locking castors
- Easily reconfigured
- Priced in Category 1 fabric
- 100s of fabric options \$POA
- Seat height 450mm
- Back height 750mm

• Square Back

• Shaped Back

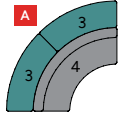

3pce
- 1870W x 1870D

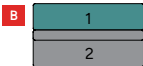

2pce
- 1872W x 1070D

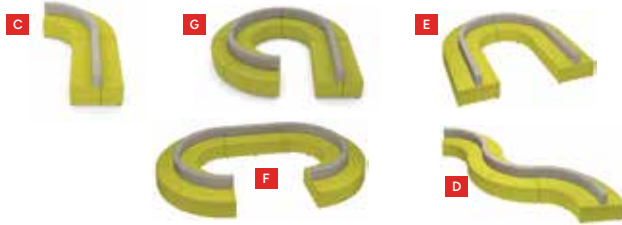

BACK STYLE	SHAPE	CODE	PRICE
NO BACK	1 - Straight	RAIN1SNB	\$879
	3 - Curve	RAIN3CNB	\$829
SQUARE BACK	2 - Straight	RAIN2SWB	\$1269
	4 - Curve	RAIN4CWB	\$1489
SHAPED BACK	2 - Straight	RAIN5SSB	\$1489
	4 - Curve	RAIN6SSB	\$1699

MACKAY TUB

NEW & IMPROVED PU



ONLY
\$459

3 YEAR WARRANTY

MACK01

- 710W x 690D x 790H • Fully assembled
- Available in Black leather-look (PU)

CUBE LOUNGE



SINGLE
\$689

3 YEAR WARRANTY

890W
CUBE41

- Also available in:
2 seater **\$999 1450W CUBE42**
3 seater **\$1299 2000W CUBE43**

- 740mm deep
- Stainless steel frame
- Black leather look (PU)
- Modern furniture, classic design

LETO FOYER



Also available in:
Cross Sled
LETOCRS01

ONLY
\$649

5 YEAR WARRANTY

LETO51

- BIFMA Certified
- Greenguard GOLD Certified
- 135kg user weight rating
- Internal Seat 570W x 515D mm
- Molded foam backrest and seat
- Black powder coated solid steel 4-star base
- 97% polyester, 3% nylon fabric upholstery

ARDINA

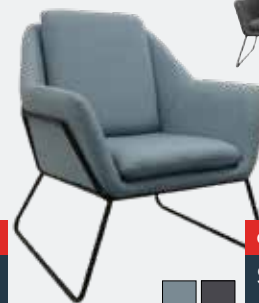

Also available in:
2 seater
\$999
ARDIN02

ONLY
\$659

5 YEAR WARRANTY

ARDIN01

- Black Powdercoat solid tube frame
- Removable back cushion
- Rubber button feet
- Available in Light Blue or Charcoal

SOUTHPORT LOUNGE

NEW & IMPROVED PU



SINGLE
\$549

760W
SOUT01

3 YEAR WARRANTY

- 740mm deep
- Black leather-look (PU)



2 SEATER
\$849

1280W
SOUT02

3 YEAR WARRANTY

- Also available in 3 seater
\$1099 1820W SOUT03

PLUTO RANGE



Ottoman
420H X 1000W X 500D
\$309 PLUT04

2 SEATER
\$1089

PLUT02

3 YEAR WARRANTY

- 750H x 740D x 1370W • Fully assembled
- Timeless comfort designed to impress
- Also available in: 1 seater **\$739 870W PLUT01**
3 seater **\$1559 2000W PLUT03**

Boardroom Tables

Ask about approved products

SOA QED
104526

HARMONY DESIGNER BOARDROOM TABLES

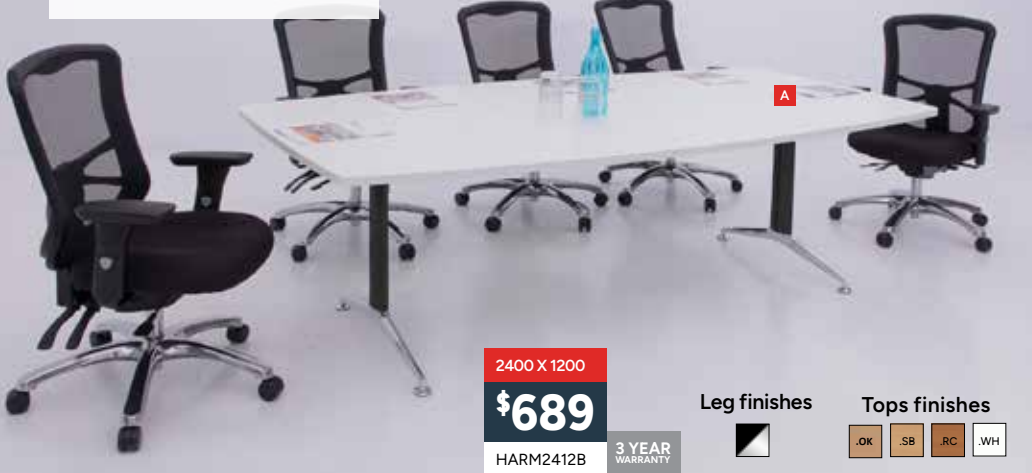

2400 X 1200
\$689
HARM2412B

3 YEAR WARRANTY

Leg finishes



Tops finishes



HARMONY BOARDROOM TABLES		BOAT-SHAPE - SELECT BEECH, RED CHERRY OR WHITE	
A	2400 X 1200 (2 LEG)	\$689	HARM2412B.xx
B	3000 X 1200 (3 LEG)	\$979	HARM3012B.xx

- Available in Boat Shaped, Rectangular and D-End
- Attractive designer frame with Chrome highlights
- Matching desk and return are also available
- Available in Red Cherry, Select Beech, or White
- Other colours available \$POA

MILANO RANGE

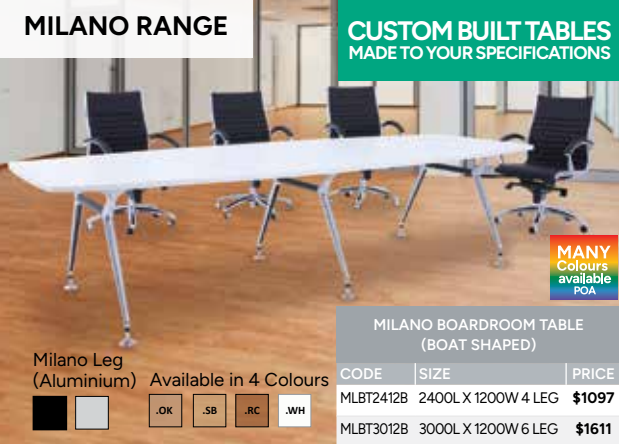

CUSTOM BUILT TABLES
MADE TO YOUR SPECIFICATIONS

MANY Colours available POA

Milano Leg (Aluminium) Available in 4 Colours

CODE	SIZE	PRICE
MLBT2412B	2400L X 1200W 4 LEG	\$1097
MLBT3012B	3000L X 1200W 6 LEG	\$1611

- Polished aluminium leg & beam construction
- Top options (\$POA) - Sharknose Edge, Flat Edge, 13mm Compact Laminate
- Also available with an in-table power/data box. \$POA
- Many sizes available

CANASTA BOARDROOM & MEETING TABLES

3000 X 1200
\$969
CABT3012B

5 YEAR WARRANTY

MANY Colours available POA



- Solid steel construction
- Adjustable feet
- Available in many other colours \$POA

NEW
1800 X 900
\$539
CAMT1890



DESIGNER LEG STYLE

- Customisable to any width between 900mm - 1000mm
- Customisable to any length between 1200mm - 2000mm

- Customisable to any width between 1000mm - 1600mm
- Customisable to any length between 2400mm - 7000mm
- Additional top shapes available (Rectangular, D-End, Tapered, Shark nose edging, \$POA)
- Available in many other colours \$POA

Tops .OK .WH .RC .SB Frames .WH .BK

CANASTA TABLES			
CODE	SIZE	BOAT SHAPE BOARDROOM	RECTANGULAR MEETING
CABT2412B	2400 X 1200	\$689	
CABT3012B	3000 X 1200	\$969	
CAMT1890	1800 X 900	-	\$539

BOAT SHAPE BOARDROOM TABLE



ONLY
\$700
SHBT3012B

10 YEAR WARRANTY

- Red Cherry/Ironstone
- Select Beech/Ironstone
- White/Silver
- Oak/White

- 3000L x 1200D
- 2 piece top
- Scalloped base

D-END BOARDROOM TABLE



SEATS 8-10 PEOPLE

ONLY
\$419
SHBT2412D

10 YEAR WARRANTY

- 2400L x 1200W

Meeting Tables and Benches

DISCUS TABLE

VARIETY OF
TOP COLOURS
AVAILABLE



ONLY
\$249

1000 TOP
DISCTB1000

MANY
Colours
available
POA

5 YEAR
WARRANTY

Tops Bases

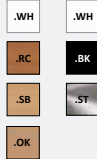

ONLY
\$289

1000 TOP
LUNA10

TOP DIA	CODE	BASE OPTIONS	
		BLACK/WHITE	STAINLESS
1000	DISCTB1000	\$249	-
1200	DISCTB1200	\$369	-
1000	*LUNA10	-	\$289
1200	*LUNA12	-	\$439

DISCUS COFFEE TABLES

ONLY
\$169

DISCCT600

Tops Bases

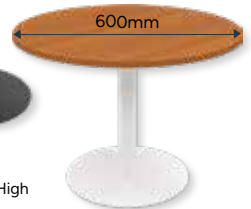
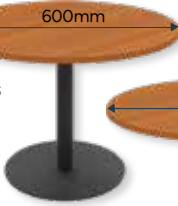

- 440mm High

MANY
Colours
available
POA

TOP DIA	CODE	BASE OPTIONS	
		BLACK/WHITE	STAINLESS
600	DISCCT600	\$169	-
600	LUNA01	-	\$189

MILANO ROUND TABLES

FROM
\$651

Milano Leg (Aluminium)



Available in 4 Colours



MILANO ROUND TABLE		
CODE	SIZE	PRICE
MLMT10	1000 DIAMETER - 3 LEGS	\$651
MLMT12	1200 DIAMETER - 4 LEGS	\$863

MANY
Colours
available
POA

CANASTA ROUND TABLE

FROM
\$399

Frames



Tops



1000 TOP
CAMT1000

CANASTA ROUND TABLES		
CODE	TOP DIA	PRICE
CAMT1000	1000	\$399
CAMT1200	1200	\$439



DESIGNER
LEG STYLE

- Solid steel construction
- Adjustable feet
- Customisable to any size between 1000mm - 1300mm (round or square)
- Available in many other colours \$POA

CITI & AXIOM BENCHES

- Range of sizes
- Lengths: (CT) 1200, 1500, 1800mm (AX) 2400, 3000, 3600mm
- Depths: (CT) 600, 750, 900 (AX) 1200mm
- Heights: 1050mm or 900mm
- Double frames available for long benches (AXBL)
- Many options available

Tops

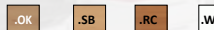

Frames



Citi 50/50 Bench	Static (Adj Feet)		Mobile (Lockable Castors)	
TOP SIZE	CODE	PRICE	CODE	PRICE
1200 X 600	CT5BEX1260	\$529	CT5BEXM1260	\$549
1500 X 750	CT5BEX1575	\$584	CT5BEXM1575	\$604
1800 X 750	CT5BEX1875	\$619	CT5BEXM1875	\$639
1800 X 900	CT5BEX1890	\$679	CT5BEXM1890	\$699

x = H (1050mm high) or L (900mm high)

MANY
Colours
available
POA

MOBILE BENCH



CHUNK BAR TABLE

1200 X 700

\$849

CHUDBT12

- Solid Rubberwood timber grain with
- Polyurethane finish
- 90mm x 90mm solid legs
- Height: 1050mm
- Available in Light Oak or Walnut
- Also available in 1800mm x 700mm

\$999 CHUDBT18



- e**
EXPRESS
QUICKSHIP
- 10 YEAR**
WARRANTY
-  Red Cherry/Ironstone
 -  Select Beech/Ironstone
 -  White/Silver
 -  Oak/White



SQUARELINE

Square handle is standard on Silver/White/Oak items only.
Swap out option.
Also sold separately.



SHIPSHAPE

- EO Environmentally Friendly board
- 10 year commercial warranty
- Flat-packed or fully assembled
- 100s of products

- 4 colour combos for quick delivery
- Metal-sided drawers and runners with solid bases
- Strong cammed-construction for easy assembly
- Ball-bearing full extension runners on file drawers

- 25mm on 18mm solid melamine construction
- 2mm hard-wearing rigid PVC edge
- 2 cable entry points in all desks (excluding P-Desk)

LOCKABLE
FULL
EXTENSION
BALL BEARING
RUNNERS

C

CREDENZA

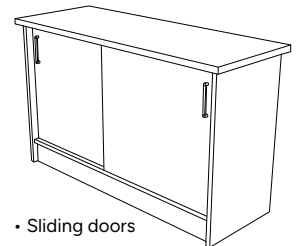

- Sliding doors

CODE	SIZE	PRICE
#SHCR12	1200W X 725H X 450D	\$349
SHCR15	1500W X 725H X 450D	\$399
#SHCR18	1800W X 725H X 450D	\$519



HOW HEALTHY IS YOUR OFFICE?

EXCLUSIVE TO EMPIRE Our SHIPSHAPE range uses board containing near to zero formaldehyde... Does yours?



A

STRAIGHT DESK

(OPEN) - 3/4 MODESTY

CODE	SIZE	PRICE
SHDK1260	1200W X 600D	\$189
SHDK1575	1500W X 750D	\$199
#SHDK1590	1500W X 900D	\$269

#Not available in Cherry

CODE	SIZE	PRICE
SHDK1875	1800W X 750D	\$269
SHDK1890	1800W X 900D	\$289
#SHDK2190*	2100W X 900D	\$379

*Full Modesty

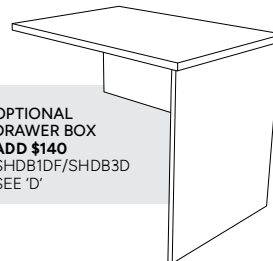

OPTIONAL
DRAWER BOX
ADD \$140
SHDB1DF/SHDB3D
SEE 'D'

B

RETURN (OPEN)

CODE	SIZE	PRICE
SHRT09	900W X 600D X 727H	\$129
#SHRT12	1200W X 600D X 727H	\$149

- Available in left or right (Universal)

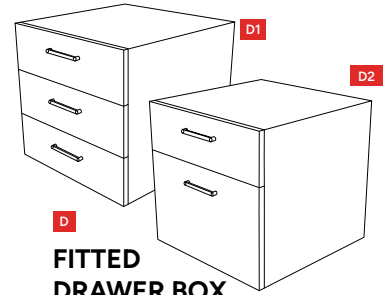

D

FITTED DRAWER BOX

CODE	SIZE	PRICE
SHDB3D	3 DRAWER	\$140
SHDB1DF	1 DRAWER + FILE	\$140

- Full extension ball bearing runner on file drawer
- 450H x 463W x 473D

NEW Oak and White



IN STOCK
FOR QUICK DELIVERY

WE WILL BEAT ANY WRITTEN QUOTE...EMPIRE ALWAYS GUARANTEES THE LOWEST PRICES*

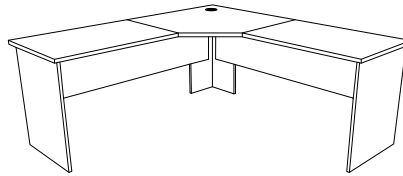
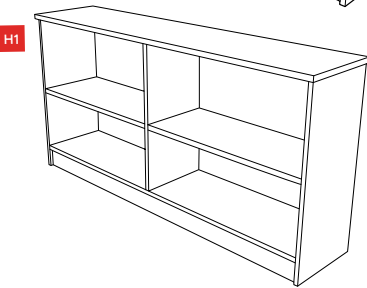
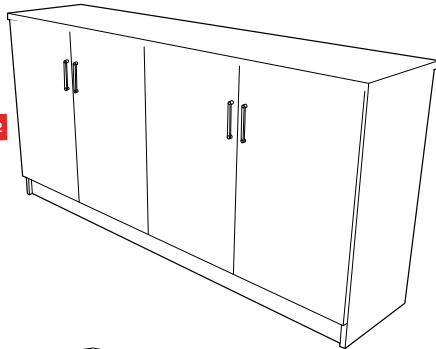

CORNER WORKSTATION (OPEN)

CODE	SIZE	PRICE	CODE	SIZE	PRICE
SHWS61212	1200W X 1200W X 600D	\$319	SHWS61521	2100W X 1500W X 600D	\$399
SHWS61215	1200W X 1500W X 600D	\$339	SHWS61821	2100W X 1800W X 600D	\$419
SHWS61218	1200W X 1800W X 600D	\$349	SHWS62121	2100W X 2100W X 600D	\$449
SHWS61515	1500W X 1500W X 600D	\$349	SHWS71818	1800W X 1800W X 750D	\$489
SHWS61518	1800W X 1500W X 600D	\$369	SHWS71821	2100W X 1800W X 750D	\$539
SHWS61818	1800W X 1800W X 600D	\$399	SHWS72121	2100W X 2100W X 750D	\$589

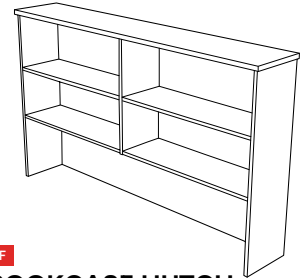

BOOKCASE HUTCH

CODE	SIZE	PRICE
#SHHU12	1200W X 320D X 1075H	\$279
SHHU15	1500W X 320D X 1075H	\$309
#SHHU18	1800W X 320D X 1075H	\$369

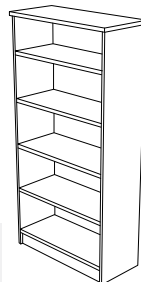

EXTRA SHELF \$35
SHSH900

DELUXE BOOKCASE

CODE	SIZE	LEVELS	PRICE
SHBC09	900H X 900W X 400D	2	\$209
#SHBC12	1200H X 900W X 400D	3	\$249
SHBC18	1800H X 900W X 400D	5	\$349

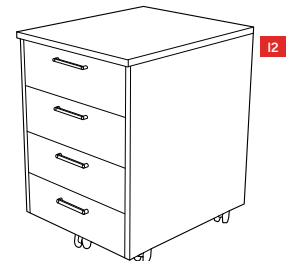
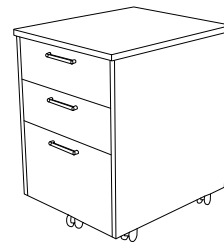

MOBILE PEDESTAL

CODE	SIZE	PRICE
I1 SHMP2DF	2 DRAWER + FILE	\$249
I2 SHMP4D	4 DRAWER	\$259

- 470W x 560D x 640H
- Full extension ball bearing runners
- Metal sided drawers
- Ironstone or White

DELUXE HORIZONTAL BOOKCASE

CODE	SIZE	PRICE
#SHBC0918	900H X 1800W X 400D	\$519
#SHSC0918	WITH DOORS	\$799

#Not available in Cherry



SQUARELINE
Square handle is standard on Silver/White/Oak items only.
Swap out option.
Also sold separately.

 **\$7 EACH**
HANDLE01

K
STORAGE CUPBOARD
(INCLUDES HALF DOORS)

CODE	SIZE	LEVELS	PRICE
SHSC18HD	1800W X 900W X 400D	5	\$489

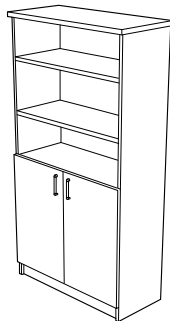

J
MEETING TABLE

CODE	SIZE	PRICE
#SHMT1000	1000MM DIAMETER	\$209

• X-base

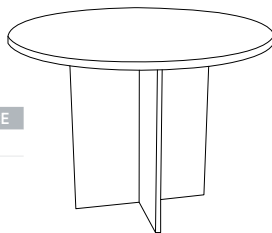

O
FILING CABINET

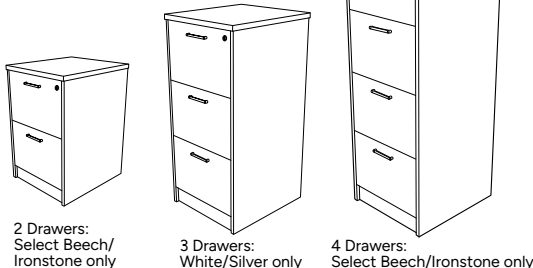

2 Drawers:
Select Beech/
Ironstone only

3 Drawers:
White/Silver only

4 Drawers:
Select Beech/Ironstone only

CODE	SIZE	PRICE
#SHFC2D	2 DRW - 750H X 490W X 556D	\$259
#SHFC3D	3 DRW - 1066H X 490W X 556D	\$349
#SHFC4D	4 DRW - 1385H X 490W X 556DX 556D	\$469

LOCKABLE FULL EXTENSION BALL BEARING RUNNERS

SCAN TO VIEW



RUN-OUT SPECIALS

L
STORAGE CUPBOARD
(INCLUDES FULL DOORS)

CODE	SIZE	LEVELS	PRICE
SHSC09	900H X 900W X 400D	2	\$349
#SHSC12	1200H X 900W X 400D	3	\$409
SHSC18	1800H X 900W X 400D	5	\$519

• 25mm shelves • 18mm back



M
DESK HEIGHT CREDENZA

CODE	SIZE	PRICE
#SHCR09	900W X 600D X 725H	\$309

• Hinged doors

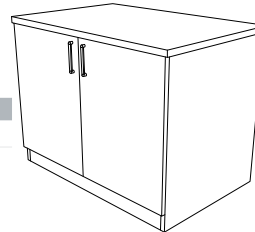

N
3 TIER MOBILE CABINET

CODE	SIZE	PRICE
#SHMOB2T	600W X 450D X 675H	\$189

• Available in Ironstone or White

#Not available in Cherry

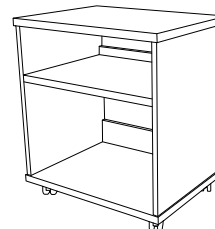

DESK ACCESSORIES
STANDARD MONITOR STAND

500W x 350D x 150H



ONLY

\$59

SHMSREC

• White only

FLIP DESK ORGANISER



Flip 90°
Ironstone or White

320W x 320W x 450H

ONLY

\$69

SHFLIP

SHIPSHAPE STRAIGHT DESK (OPEN)

1500 x 750

\$199

NO DRAWERS
SHDK1575

1800 x 750

\$269

NO DRAWERS
SHDK1875

10 YEAR WARRANTY



Full details on page 8

OPTIONAL
DRAWER BOX
\$140
SHDB1F



SHIPSHAPE CORNER WORKSTATION (OPEN)

1800 X 1800 X 600D

Full details on page 9

ONLY

\$399

SHWS61818

10 YEAR WARRANTY

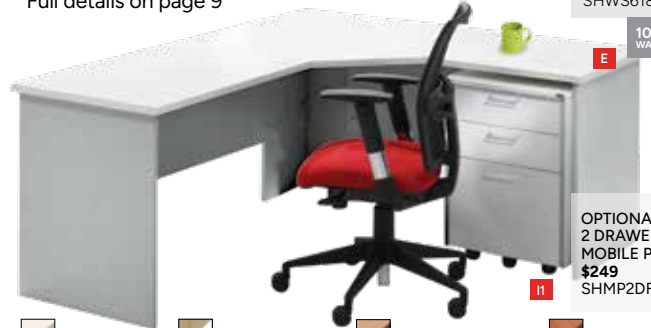

OPTIONAL
2 DRAWER + FILE
MOBILE PED
\$249
SHMP2DF



FROM

\$259

BZDK1275

- Sturdy powdercoated frame and legs
- Comes with metal perforated modesty panel
- Range of sizes to choose from to suit your space
- E0 Melamine top
- 730H
- 750mm deep top for more workspace
- All tops available with cable holes, scallop tops or plain tops (Scallop tops available in Oak and White only)

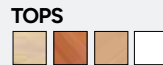

STRAIGHT DESKS		
DIMENSIONS (mm)	CODE	PRICE
1200 X 750*	BZDK1275	\$259
1500 X 750	BZDK1575	\$279
1800 X 750	BZDK1875	\$299

CORNER WORKSTATIONS		
DIMENSIONS (mm)	CODE	PRICE
1500 X 1500	BZWS1515	\$479
1800 X 1200	BZWS1815	\$499
1800 X 1500	BZWS1818	\$529

*Not available in plain tops

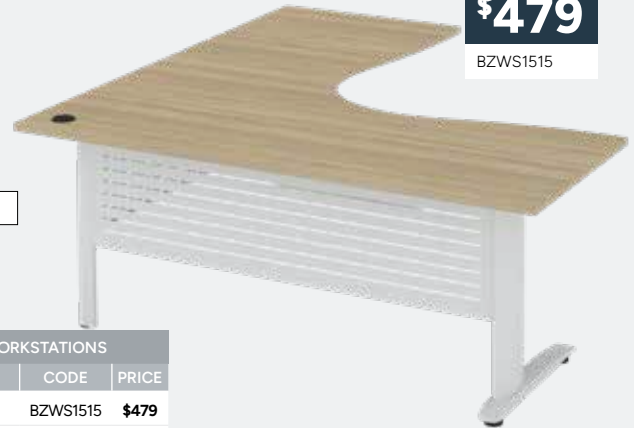

FROM

\$479

BZWS1515

5 YEAR WARRANTY **zero**



MILANO DESK

- Polished aluminium leg and beam constructions (Polished or Black)
- Available in 25mm melamine with Straight Edge or Sharknose Edge
- Squareline Brushed Silver handles
- Levelling adjustment in feet • 22 Top colours available
- Many customised sizes and combinations available

A	STRAIGHT DESK		B	MODESTY PANEL SUITS 1800mm LONG DESK	
	25mm FLAT EDGE	SHARKNOSE		MELAMINE (AS PICTURED) MOD164.XX	BREEZE MODESTY PANEL BZCDKMP1800
	1800W X 900D X 725H MLDK1890	\$997		\$1087	\$106
	2100W X 900D X 725H MLDK2190	\$1037		\$1127	\$70

FITTED RETURN - 1200W (NOT PICTURED)		25mm FLAT EDGE	SHARKNOSE
FULL HEIGHT PEDESTAL RETURN - MLRTP1260 2 DRAWER + FILE / 4 DRAWER / 2FILE DRAWERS		\$449	\$499
700D X 725H - MLRT1270 OPEN RETURN - WITH MILANO LEG		\$519	\$569

MANY Colours available PCN 5 YEAR WARRANTY

Citi Desks and Screens

Creating an architecturally inspired workspace is now easier with Empire!

The Citi system offers style, uncompromising strength and practicality. The range includes everything you need for a complete office desk and storage system, including add-on elements like divider screens and cable management. Solid steel frame construction and support beams prevent bowing and ensure maximum stability. All Citi items include a 10 Year warranty.

10 YEAR WARRANTY

1. Determine the number of users and desk layout

Desks are available in a variety of shapes and sizes and can either be utilised as single desks or combined into a myriad of settings to suit your space.

WORKTOPS - STRAIGHT

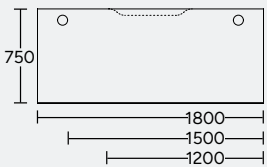

Straight worktops offer choice of 2x cable caps or scallop cable entry

WORKTOPS - L-SHAPE

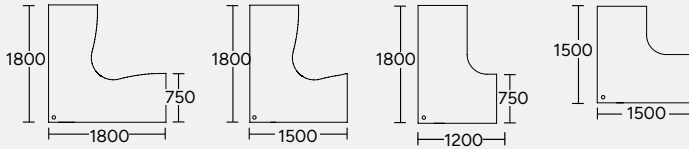

STANDARD COLOURS AND FINISHES:

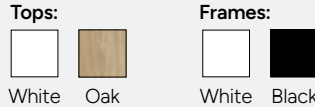

2. Choose the leg system

Citi is available in standard "50/50" straight legs or contemporary "Loop" and "A-leg" frames. Full fabric panel systems can also be utilised instead of legs - these are called 'Divided' systems.

50/50

LOOP LEG

A-LEG



3. Determine divider screen requirements

The Citi system offers standard Citi divider screens that can be mounted on top of desks or noise-reducing acoustic solutions in the "Acoustico" screens. Alternatively, full height Citi panel screens run from the floor to above the desk, while 'Divided' panel screens go one step further and utilise screens as legs, therefore negating the need for actual 'legs' on the desks.

DESKTOP SCREEN

FULL SCREEN HEIGHT

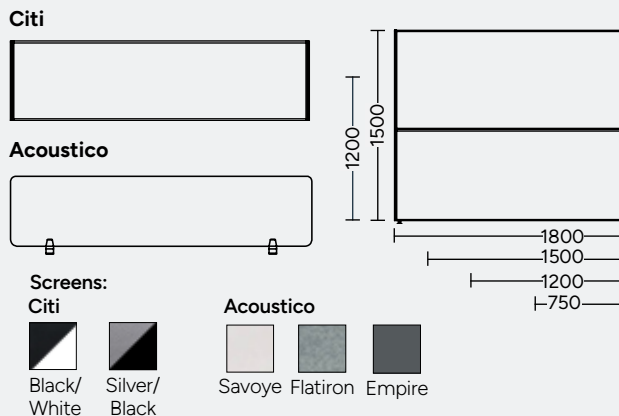

4. Determine cable management requirements

Soft wiring, modular wiring or 'plug & play' wiring enables the easy use and re-use of electrical wiring components when installing or re-configuring commercial office workstations without the waste associated with hard-wiring.



ALSO AVAILABLE IN NOISE REDUCING ACOUSTIC SCREENS



CITI STRAIGHT DESK



CITI WORKSTATION



FROM \$644
CT5SWS1515



The Ultimate Office Furniture System

it's easier with
empire
office furniture



T-POD
\$661
PER PERSON
1500W X 1500W
CT5MLT21515

X-POD
\$700
PER PERSON
1500W X 1500W
X 750D
CT5MLX41515

BACK-TO-BACK
\$363
PER PERSON
1500W X 750D
CT5MBB41575C/S

zero

HOW HEALTHY IS YOUR OFFICE?

EXCLUSIVE TO EMPIRE
Our CITI range uses board containing near to zero formaldehyde...
Does yours?



SEE THE FULL RANGE IN OUR
WORKSTATION SYSTEMS CATALOGUE
AT empirefurniture.com.au

SINGLE USER SETTINGS

FROM
\$359
CTASDK1260/C



SCAN TO VIEW



RUN-OUT SPECIALS

D FREESTANDING DESK & TABLES

Citi 50/50 & A-Leg		Citi Loop		
TOP SIZE (mm)	CODE	PRICE	CODE	PRICE
1200W X 600D	CTXSDK1260/C	\$359	CTLSDK1260/C	\$399
1200W X 750D	CTXSDK1275/C/S	\$369	CTLSDK1275/C/S	\$419
1500W X 750D	CTXSDK1575/C/S	\$389	CTLSDK1575/C/S	\$439
1800W X 750D	CTXSDK1875/C/S	\$419	CTLSDK1875/C/S	\$469
1800W X 900D	CTXSDK1890/C	\$469	CTLSDK1890/C	\$549



DIMENSIONS (mm)	CITI 50/50 & A-LEG		CITI LOOP	
	CODE	PRICE	CODE	PRICE
1500W X 1500W X 750D	CTXSWS1515	\$644	CTLSWS1515	\$704
1800W X 1200W X 750D	CTXSWS1812	\$592	CTLSWS1812	\$684
1800W X 1500W X 750D	CTXSWS1815	\$674	CTLSWS1815	\$734
1800W X 1800W X 750D	CTXSWS1818	\$699	CTLSWS1818	\$764

*Use "CT5" for 50/50 leg, use "CTA" for A-Leg

FROM
\$769
PER PERSON
CTXSDKEX1818
+BZCDKMP1800

COMPLETE EXECUTIVE SETTING

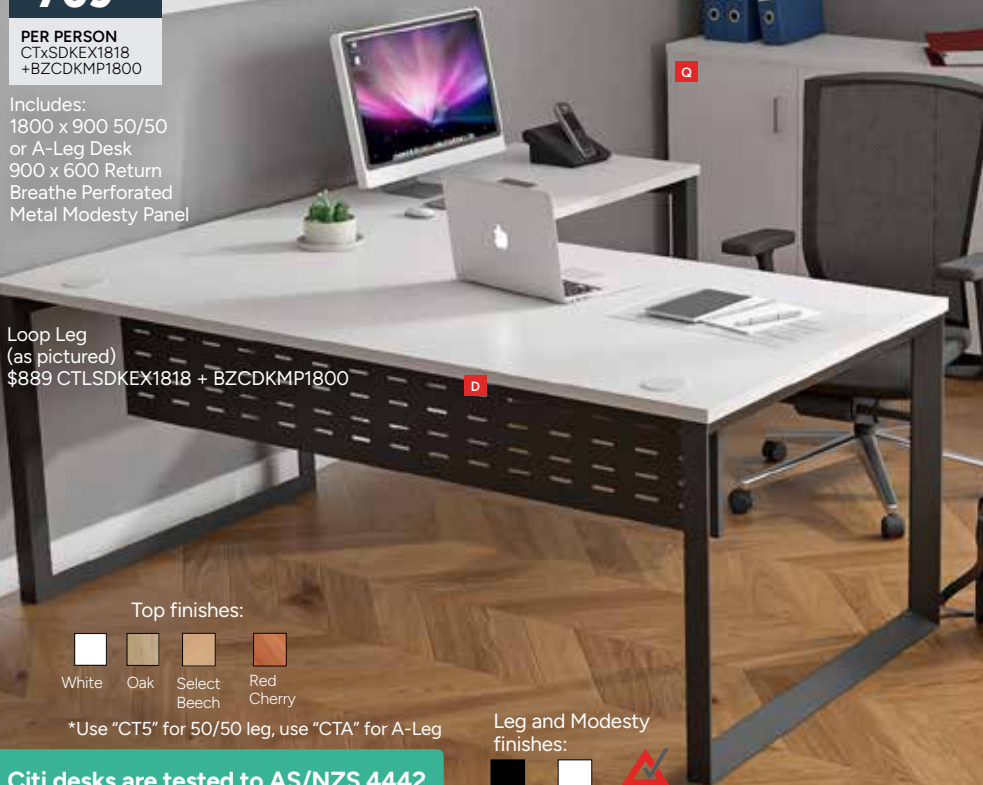

Includes:
1800 x 900 50/50
or A-Leg Desk
900 x 600 Return
Breathe Perforated
Metal Modesty Panel

Loop Leg
(as pictured)
\$889 CTLSDKEX1818 + BZCDKMP1800

Top finishes:

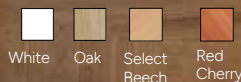

White Oak Select Beech Red Cherry

*Use "CT5" for 50/50 leg, use "CTA" for A-Leg

Leg and Modesty finishes:

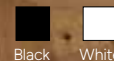

Black White



Citi desks are tested to AS/NZS 4442

Citi Desks and Screens

Ask about approved products

SOA QED
104526

MULTI USER SETTINGS - STRAIGHT TOP OPTIONS

SINGLE SIDED FROM

\$337

PER PERSON
CT5MSS21275C/S

E

CHOICE OF CITI 480H
SCREENS OR NOISE
REDUCING ACOUSTICO
420H SCREENS

SINGLE SIDED SETTING (PRICED PER PERSON)

CODE	TOP SIZE	50/50 OR A-LEG NO SCREENS		LOOP LEG NO SCREENS		CITI PANEL SYSTEM WITH 1200mm HIGH SCREENS & 50/50 LEGS.		
		2 USER	3 USER	2 USER	3 USER	1 USER	2 USER	3 USER
CT#MSSX1275C/S	1200W X 750D	\$337	\$321	\$357	\$334	\$659	\$585	\$583
CT#MSSX1575C/S	1500W X 750D	\$350	\$333	\$377	\$354	\$719	\$640	\$640
CT#MSSX1875C/S	1800W X 750D	\$375	\$367	\$407	\$384	\$799	\$715	\$710

= LEG STYLE (5 = 50/50, A = A-LEG, L = LOOP LEG, 5P = PANEL SYSTEM)
X = NO OF USERS

Prices are per user

DESK-TOP SCREEN

- 480mm above desk height
- 32mm slimline finish
- Mounted with sturdy steel brackets
- Finish – White or Black powder coated aluminium frame
- Commercial fabric: 2 standard colours (other colours available \$POA)
- "Pinnable" surface

WORK TOP (FINISHED HEIGHT 720 mm + 10 mm ADJUSTABLE FEET)

- 25mm EO Melamine (Environmentally-friendly)
- Choice of 2x Cable entries or a scallop top
- Melamine colour - White or Oak (other colours available \$POA)
- 2mm impact resistant solid PVC edging
- 750mm deep in 3 lengths

Citi STANDARD SCREEN FABRICS



 White frame/Black fabric
 Black frame/Silver fabric



 White Oak

ADDITIONAL COLOURS AVAILABLE

BACK-TO-BACK FROM

\$340

PER PERSON
CT5MBB41275C/S

B

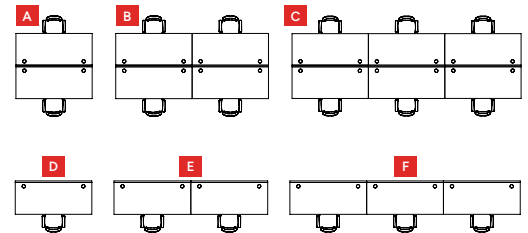

CITI BACK-TO-BACK (4 PERSON)

FROM

\$370

PER PERSON
CTLMBB41275C/S

B

BACK TO BACK SETTING (PRICED PER PERSON)

CODE	TOP SIZE	50/50 OR A-LEG WITH SCREEN			LOOP LEG WITH SCREEN			CITI PANEL SYSTEM WITH 1200mm HIGH SCREENS & 50/50 LEGS.		
		2 USER	4 USER	6 USER	2 USER	4 USER	6 USER	2 USER	4 USER	6 USER
CT#MBBX1275C/S	1200W X 750D	\$370	\$340	\$330	\$433	\$370	\$352	\$495	\$446	\$431
CT#MBBX1575C/S	1500W X 750D	\$395	\$363	\$353	\$460	\$395	\$374	\$530	\$481	\$466
CT#MBBX1875C/S	1800W X 750D	\$428	\$395	\$385	\$495	\$425	\$407	\$580	\$531	\$519

= LEG STYLE (5 = 50/50, A = A-LEG, L = LOOP LEG, 5P = PANEL SYSTEM) X = NO OF USERS

Prices are per user



• Shown with Loop leg

Citi Desks and Screens

MULTI USER SETTINGS - L SHAPE OPTIONS

FROM

\$677

PER PERSON
CTAMLX41812

CITI 'X' POD (4 PERSON)



4 PERSON

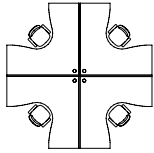

• Shown with A-leg

4 PERSON "X" SETTING (PRICED PER PERSON)

50/50 OR A-LEG WITH SCREEN	LOOP LEG WITH SCREEN	CITI PANEL SYSTEM WITH 1200mm HIGH SCREENS & 50/50 LEGS.
4 USER	4 USER	4 USER

CODE	TOP SIZE	4 USER	4 USER	4 USER
CT#MLX41812	1800WX1200WX750D	\$677	\$757	\$625
CT#MLX41515	1500WX1500WX750D	\$700	\$768	\$640
CT#MLX41815	1800WX1500WX750D	\$649	\$805	\$688
CT#MLX41818	1800WX1800WX750D	\$774	\$825	\$733

= LEG STYLE (5 = 50/50, A = A-LEG, L = LOOP LEG, 5P = PANEL SYSTEM)

Prices are per user

ACOUSTICO
SCREEN
FABRICS

EMP FLA SAV

ADDITIONAL COLOURS
AVAILABLE

CITI 'T' POD (2 PERSON)

FROM

\$922

PER PERSON
CT5PLT21818

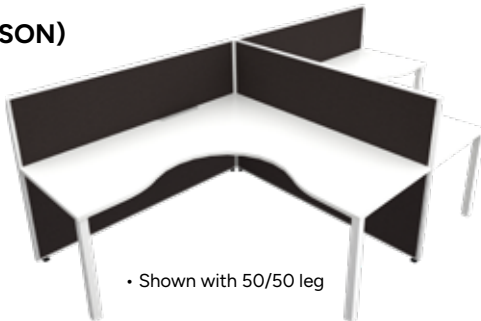

• Shown with 50/50 leg

2 PERSON "T" SETTING (PRICED PER PERSON)

50/50 OR A-LEG WITH SCREEN	LOOP LEG WITH SCREEN	CITI PANEL SYSTEM WITH 1200mm HIGH SCREENS & 50/50 LEGS.
2 USER	2 USER	2 USER

CODE	TOP SIZE	2 USER	2 USER	2 USER
CT#MLT21812	1800WX1200WX750D	\$636	\$716	\$814
CT#MLT21515	1500WX1500WX750D	\$661	\$746	\$804
CT#MLT21815	1800WX1500WX750D	\$663	\$771	\$849
CT#MLT21818	1800WX1800WX750D	\$707	\$807	\$922

= LEG STYLE (5 = 50/50, A = A-LEG, L = LOOP LEG, 5P = PANEL SYSTEM)

Prices are per user

2 PERSON

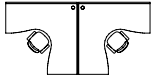

Citi FRAMES
AVAILABLE IN
BLACK OR WHITE
50/50, A-LEG
AND LOOP

Citi
120°
PANEL SYSTEM



FROM

\$548

PER PERSON
CT5P12091212

3 PERSON
2760mm



6 PERSON
4780mm



9 PERSON
6950mm



FROM

\$593

CTDPBB61275C/S

CALL CENTRE
PODS



Citi

PANEL SYSTEM

1200mm or 1500mm High

- 32mm slimline finish
- Available in 2 heights. 1200mm (shown) and 1500mm & 4 widths
- Choice of Black fabric/ White powdercoated aluminium frame OR Silver fabric/ Black powdercoated aluminium frame
- Other fabric colours available \$POA
- Full height fabric coverage

POP-IN POWER & USB
\$139



SOFT80

Citi PANEL SYSTEMS

VIEW THE **CITI**
WORKSTATION
CATALOGUE FOR
MORE LAYOUT
OPTIONS



SCAN HERE
TO VIEW
THE
CATALOGUE



Citi Storage & Add-Ons

Ask about approved products

SOA QED
104526

CITI BOOKCASE & CUPBOARD



DIMENSIONS (mm)	NO DOORS			WITH DOORS		
	CODE	PRICE		CODE	PRICE	
900mm HIGH	CTBC09 N3	\$229		CTSC09 O3	\$369	
1200mm HIGH	CTBC12 N2	\$279		CTSC12 O2	\$439	
1800mm HIGH	CTBC18 N1	\$399		CTSC18 O1	\$569	

CITI HALF DOOR BOOKCASE



DIMENSIONS (mm)	CODE	PRICE	REF.
1800H X 900W X 400D	CTSC18HD	\$539	P

SCREEN HUNG SHELF

(For panel system only)



REF.	DIMENSIONS (mm)	CODE	PRICE
X	600W X 300D	CTACSCSH600.WH	\$60
X	450W X 300D	CTACSCSH450.WH	\$60

DESK MOUNTED SHELF



REF.	DIMENSIONS (mm)	CODE	PRICE
G	600W X 300D	CTDMSH600	\$120
G	450W X 300D	CTDMSH450	\$120

CITI HORIZONTAL CUPBOARD



ONLY
\$839
CTSC0918

CITI HORIZONTAL BOOKCASE



ONLY
\$559
CTBC0918

• 900H x 1800W x 400D

CITI MOBILE CADDY

- 579H x 994W x 520D
- Mix and match configurations

CODE	PRICE	REF.
CTMCSHSH	\$279	S1 + S1
CTMCSHDF	\$419	S1 + S2
CTMCD3D	\$559	S2 + S3

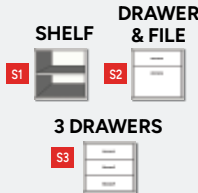

S1 + S2



CADDY CUSHION for Mobile Peds or Caddies
ONLY \$30 SAVE \$10 CTTOPPA

DESK HUNG SCREEN (CITI OR ACOUSTICO)



SUITS TOP SIZE	CITI FABRIC 900mm HIGH		ACOUSTICO 600mm HIGH	
	CODE	PRICE	CODE	PRICE
750mm	CTDH0975	\$209	APDH40606	\$123
1200mm	CTDH0912	\$249	APDH41106	\$197
1500mm	CTDH0915	\$279	APDH41406	\$346
1800mm	CTDH0918	\$299	APDH41706	\$346

Acoustico: BLACK FABRIC/WHITE FRAME OR SILVER FABRIC/BLACK FRAME
Citi: SAVOYE, FLATIRON & EMPIRE



CLAMP ON SCREEN (CITI OR ACOUSTICO)



- Easy attachment
- Suits most standard desks



SUITS TOP SIZE	CITI FABRIC 480mm HIGH		ACOUSTICO 400mm HIGH	
	CODE	PRICE	CODE	PRICE
750mm	CTDM0575	\$109	APBR0406	\$82
1200mm	CTDM0512	\$177	APBR0411	\$132
1500mm	CTDM0515	\$202	APBR0414	\$247
1800mm	CTDM0518	\$222	APBR0417	\$247

Acoustico: BLACK FABRIC/WHITE FRAME OR SILVER FABRIC/BLACK FRAME
Citi: SAVOYE, FLATIRON & EMPIRE



Electric Height Adjustable Desks

UPTOWN HEIGHT ADJUSTABLE ELECTRIC DESKS

"UPTOWN" Sit-Stand ...at Downtown Prices!



- 1 motor, 2-Step frame
- Single button control
- 80kg lift capacity
- Black or White frame
- 32mm/sec
- Range: 665mm to 1125mm

FROM
\$539

UP2DK1260C

**New
Lower
Prices**

CODE	SIZE	PRICE	SAVE
UP2DK1260C	1200W X 600D	\$539	\$150
UP2DK1275C/S	1200W X 750D	\$549	\$150
UP2DK1575C/S	1500W X 750D	\$559	\$150
UP2DK1875C/S	1800W X 750D	\$569	\$160

Tops



Frames



Available in Black and White

CABLE BASKETS

- Single tier Cable Basket
- Includes mounting brackets (pair)
- Powered includes Quad GPO Outlet with Mounting Clip and 1.5m 3-Pin Starter Lead



CABLE BASKET	SUITS DESK (mm)	POWERED	UNPOWERED
SWCB950X	1200mm	\$110	\$30
SWCB1250X	1500mm	\$115	\$34
SWCB1550X	1800mm	\$119	\$38

CABLE UMBILICAL



ONLY

\$49

ALTU1300

- Black or White
- 1300mm Long
- For Sit-Stand Desks

COMFY ANTI FATIGUE MAT FOR SIT-TO-STAND DESKS



- Thick, dense, durable one-piece Polyurethane closed cell foam
- PVC free and easy to clean

780 X 520

\$69

COMF0805

ONLY

\$319

PERCH01

10 YEAR WARRANTY

PERCH STOOL



- Gas lift
- Seat height range 595-840mm
- Seat diameter 300mm
- Available in Black or Blue



"BOB" DESKTOP SIT-STAND ELECTRIC MONITOR STAND

- Unique gas strut provides neutral buoyancy for easy one-hand adjustment
- New X-Lift mechanism for "Straight" up and down
- Superior height range - 410mm travel
- Minimum desktop depth - straight (700mm), corner (no limit)

OVERALL FOOTPRINT - 900 x 670mm	MAX WEIGHT	CODE	ELECTRIC LIFT
NO MONITOR ARM	15KG	BOB30E	\$469
SINGLE MONITOR ARM	15KG*	BOB30EM1	\$569
DUAL MONITOR ARM	8KG*	BOB30EM2	\$619

5 YEAR WARRANTY



*Monitor weight per arm

Electric Height Adjustable Desks

Ask about approved products

SOA QED
104526

BACK-TO-BACK

\$1025

PER PERSON
1500W X 750D
ALxBBTP1575C/S

F

Joining kit
add \$82
ALJBLBB

FREE
SPACE PLANNING &
DESIGN SERVICE



ALTURA STRAIGHT DESK

A

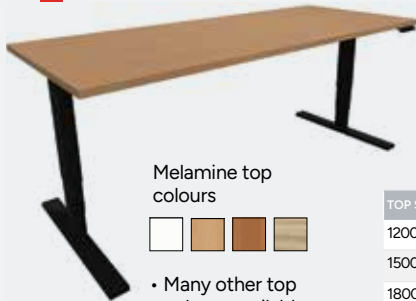

Melamine top colours



• Many other top colours available.
\$POA

FROM

\$789

ALxDK1275C/S

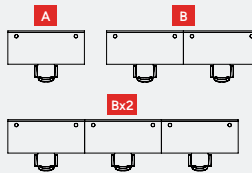

As shown **\$1249**
ALxDKTP1875C/S

STRAIGHT DESKS HEIGHT ADJUSTABLE

TOP SIZE (mm)	DESK ONLY (NO TRAY OR SCREEN)		TRAY ONLY (NO SCREEN)		SCREEN ONLY (NO TRAY)		WITH TRAY & CITI SCREEN		FIXED HEIGHT BASIC (NO TRAY OR SCREEN)	
	CODE*	PRICE	CODE*	PRICE	CODE*	PRICE	CODE*	PRICE	CODE*	PRICE
1200W X 750D	ALxDK1275C/S	\$789	ALxDK1275C/S	\$919	ALxDKP1275C/S	\$1049	ALxDKTP1275C/S	\$1149	ALxDKFX1275	\$419
1500W X 750D	ALxDK1575C/S	\$799	ALxDK1575C/S	\$949	ALxDKP1575C/S	\$1099	ALxDKTP1575C/S	\$1199	ALxDKFX1575	\$429
1800W X 750D	ALxDK1875C/S	\$819	ALxDK1875C/S	\$999	ALxDKP1875C/S	\$1149	ALxDKTP1875C/S	\$1249	ALxDKFX1875	\$449
1800W X 900D	ALxDK1890C	\$849	-	-	-	-	-	-	ALxDKFX1890	\$479
B JOINING KIT (NO DIVIDING SCREEN)			ALCSSBRIDGE	\$40	ALJLSS	\$32	ALJBLSS	\$72	-	-

ALTURA SINGLE WORKSTATIONS

C



FROM

\$1309

ALxWS1515

Top finishes: Leg finishes:



Standard screen fabrics:



As shown **\$1749**
ALxWSTP1515



L - SHAPE HEIGHT ADJUSTABLE

TOP SIZE (mm)	WORKSTATION ONLY (NO TRAY OR SCREEN)		TRAY ONLY (NO SCREEN)		SCREEN ONLY (NO TRAY)		WITH TRAY & CITI SCREEN		FIXED HEIGHT BASIC (NO TRAY OR SCREEN)	
	CODE*	PRICE	CODE*	PRICE	CODE*	PRICE	CODE*	PRICE	CODE*	PRICE
1500W X1500D	ALxWS1515	\$1309	ALxWST1515	\$1479	ALxWSP1515	\$1619	ALxWSTP1515	\$1749	ALxWSFX1515	\$749
1500W X 1800D	-	-	ALxWST1518	\$1529	ALxWSP1518	\$1659	ALxWSTP1518	\$1809	-	-
1800W X 1500D	ALxWS1815	\$1329	ALxWST1815	\$1549	ALxWSP1815	\$1679	ALxWSTP1815	\$1829	ALxWSFX1815	\$769
1800W X 1800D	ALxWS1818	\$1349	ALxWST1818	\$1569	ALxWSP1818	\$1699	ALxWSTP1818	\$1839	ALxWSFX1818	\$789

*Use "R" for Round leg, use "S" for square leg

NEW Altura Electric Workstation System

it's easier with **empire**
office furniture



T-POD

\$1637

PER PERSON
1500W X 1500D
ALxLTT1515

D END SCREEN KITS

	CODE	PRICE
SINGLE SIDE	ALEPSS	\$254
BACK-TO-BACK	ALEPBB	\$476



JOINING KITS

	DIVIDING SCREENS ONLY (NO TRAY)		DIVIDING SCREENS WITH TRAY	
	CODE	PRICE	CODE	PRICE
SINGLE SIDE	ALJPSS	\$258	ALJPSS	\$298
BACK-TO-BACK	ALJPBB	\$484	ALJPBB	\$534

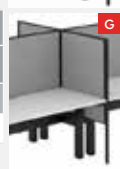

The exciting new Altura range of electric height adjustable desks and workstations makes fitting out multi-user workplaces easier! The range is extremely customisable and can be ordered with or without trays and privacy screens. Additional choices of round leg or square leg, top and frame colours makes this range unbeatable!

Altura
SIT-STAND DESK
SPECIFICATIONS

- Market leading weight rating 210kg (3 motors - L shape) & 135kg (2 motors - Rectangular)
- Height range - min 625mm, max 1270mm
- Individually motorised legs (no exposed mechanism)
- Frame colour - black, white
- Anti-collision safety feature
- 4 memory pre-sets
- Smooth, silent action
- Descends at 35mm per second
- One touch activation of height mobility makes transitions quick and easy



CHOICE OF ROUND LEG OR SQUARE LEG

Tops:



Frames:



10 YEAR WARRANTY
FRAME & MOTOR



LED CONTROL PANEL (INCLUDED)

ALTURA BACK-TO-BACK



As shown \$925
ALxBBP1875C/S

ASK ABOUT EASY CABLE MANAGEMENT OPTIONS



FROM

\$870

ALxBBT1275C/S

Top finishes: Leg finishes:



Standard screen fabrics:

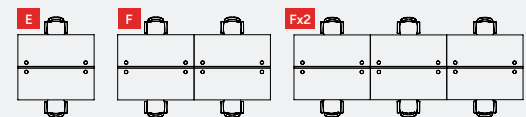

E BACK TO BACK SETTING (PRICE PER PERSON)

TOP SIZE	TRAY ONLY (NO SCREEN)		SCREEN ONLY (NO TRAY)		WITH TRAY & CITI SCREEN	
	CODE*	PRICE	CODE*	PRICE	CODE*	PRICE
1200W X 750D	ALxBBT1275C/S	\$870	ALxBBP1275C/S	\$875	ALxBBT1275C/S	\$1000
1500W X 750D	ALxBBT1575C/S	\$895	ALxBBP1575C/S	\$900	ALxBBT1575C/S	\$1025
1800W X 750D	ALxBBT1875C/S	\$920	ALxBBP1875C/S	\$925	ALxBBT1875C/S	\$1050

JOINING KIT (NO DIVIDING SCREEN)	ALCBBBRIDGE	\$50	ALJLBB	\$32	ALJLBB	\$82
----------------------------------	-------------	------	--------	------	--------	------

ALTURA T-POD



As shown \$1697
ALxLTT1818

FROM

\$1464

ALxLTT1515

H 2 PERSON

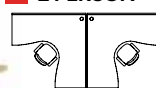

I 4 PERSON

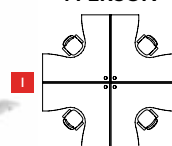

H 2 PERSON T-POD (PRICE PER PERSON)

TOP SIZE	TRAY ONLY (NO SCREEN)		SCREEN ONLY (NO TRAY)		WITH TRAY & CITI SCREEN	
	CODE*	PRICE	CODE*	PRICE	CODE*	PRICE
1500W X 1500D	ALxLTT1515	\$1464	ALxLTP1515	\$1497	ALxLTT1515	\$1637
#1500W X 1800D	ALxLTT1518	\$1484	ALxLTP1518	\$1517	ALxLTT1518	\$1657
*1800W X 1500D	ALxLTT1815	\$1494	ALxLTP1815	\$1527	ALxLTT1815	\$1677
1800W X 1800D	ALxLTT1818	\$1514	ALxLTP1818	\$1547	ALxLTT1818	\$1697

I 4 PERSON X-POD (PRICE PER PERSON)

TOP SIZE	TRAY ONLY (NO SCREEN)		SCREEN ONLY (NO TRAY)		WITH TRAY & CITI SCREEN	
	CODE*	PRICE	CODE*	PRICE	CODE*	PRICE
1500W X 1500D	ALxLXT1515	\$1476	ALxLXP1515	\$1644	ALxLXT1515	\$1796
#1500W X 1800D	ALxLXT1518	\$1487	ALxLXP1815	\$1674	ALxLXT1518	\$1826
*1800W X 1500D	ALxLXT1815	\$1497	ALxLXP1815	\$1674	ALxLXT1815	\$1836
1800W X 1800D	ALxLXT1818	\$1517	ALxLXP1818	\$1704	ALxLXT1818	\$1866

*Use "R" for Round leg, use "S" for square leg #Cable tray 1500 side ^Cable tray 1800 side

Huge Range of Tables

Ask about approved products

SOA QED
104526

4 LEG TABLES



TIMMY STEEL-FRAME TABLES & BENCHES

CHOOSE THE SIZE THAT SUITS YOUR NEEDS! BEST PRICES!

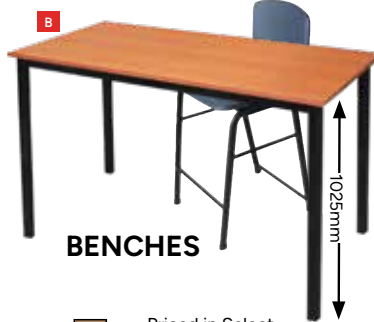

ALSO AVAILABLE
"Tested and Certified" model
Emmy steel frame table
EMSFXXX \$POA

SIZES	A 4 LEG (BLACK) (735mm H)	B BENCHES (1025mm H)	C FOLDING (SILVER) (735mm H)
900 X 600	\$224 TISF0960.XX	\$264 TISFH0960.XX	-
1200 X 600	\$259 TISF1260.XX	\$299 TISFH1260.XX	-
1500 X 750	\$294 TISF1575.XX	\$364 TISFH1575.XX	\$329 SHFT1575.XX
1800 X 750	\$319 TISF1875.XX	\$389 TISFH1875.XX	\$349 SHFT1875.XX
1800 X 900	\$359 TISF1890.XX	-	\$379 SHFT1890.XX

BENCHES

- .OK
- .SB
- .RC
- .WH

- Priced in Select Beech, Red Cherry, Natural Oak or White Tops
- Many sizes & colours available \$POA
- 40mm sturdy steel tube with 25mm Top
- Adjustable feet

FOLDING TABLES

Black frame only **.BK**

TIMMY TABLES - 19 COLOURS & MANY SIZES AVAILABLE \$POA

1. 600 X 600	6. 1200 X 600	11. 1500 X 750	16. 1800 X 900
2. 600 X 750	7. 1200 X 750	12. 1500 X 900	17. 1800 X 1200
3. 900 X 600	8. 1200 X 900	13. 1500 X 1200	18. 2100 X 600
4. 900 X 750	9. 1200 X 1200	14. 1800 X 600	19. 2100 X 750
5. 900 X 900	10. 1500 X 600	15. 1800 X 750	20. 2100 X 900

LENGTHS: 600/900/1200/1500/1800/2100mm 21. 2100 X 1200

WIDTHS: 600/750/900/1200mm HEIGHTS: 735/1025mm

ECHO FLIP TABLE

NEW BLACK FRAME AVAILABLE!



- Tops Frames
- .OK
 - .SB
 - .RC
 - .WH
 - .SV
 - .WH
 - .BK

3 FRAME COLOURS



- Adjustable length beam
- * Some colours avail. 1500 x 750 only

TOP SIZE	HEIGHT	CODE	PRICE
1500L X 750D	725mm	ECH1575	\$459
1800L X 750D	725mm	ECH1875	\$479
1500L X 750D	650mm	ECH1575L	\$459
1800L X 750D	650mm	ECH1875L	\$479

FROM **\$459**
ECH1575

3 YEAR WARRANTY

- 650mm high version - ideal for primary school

QUADRIC SCHOOL TABLES



FROM **\$155**
QDTB0705W



MANY Colours available \$POA

7 YEAR WARRANTY

BENCH **\$242**
QDBE1206



CODE	SIZE	PRICE	TOP OPTIONS
TABLES 720mm HIGH			
QDTB0705W	700W X 550D	\$155	OAK, STARDUST & ERASABLE SURFACE (ADD \$10)
QDTB1206W	1200W X 600D	\$217	OAK, STARDUST & ERASABLE SURFACE (ADD \$10)
BENCHES - 900mm HIGH			
QDBE1206	1200W X 600D	\$242	STARDUST OR ERASABLE SURFACE (ADD \$10)

NEW FULLY WELDED DESIGN

- 25mm steel frame (Black Ripple)

TIMBER VENEER LINK LAPTOP TABLE

ONLY **\$359**



SAVE \$20
340W X 470D X 648H
LINKTAB

- 65kg weight rating
- Lightweight
- Heavy duty plywood laminate construction
- Exposed wooden edges
- Clear lacquered beech veneer finish
- Multi-use positions to suit various applications

.NA .BK

"XO" SIDE

XO SIDE TABLE **\$149**



SAVE \$40
XOST400

WHILE STOCKS LAST SPECIAL

- 400mm diameter
- White lacquer top
- 640mm high, polished
- Aluminum base

.WH

SOLACE SIDE TABLE

ONLY **\$159**



SOLAST500

- Able to slide under lounges
- Oval base plate 500W x 280D
- 18mm thick EO Enviroboard top
- Powder coated underframe and base plate

Tops **.OK .WH .BK** Bases **.WH .BK**

FROM **\$219**

PEBBLE

PEBB400



- 400/350W x 400D x 650H
- Solid Steel Design with Heavy Base for Stability
- Available in Black or White

.WH .BK

UP TO 25% OFF • SELECTED COLOURS AND SHAPES • WHILE STOCKS LAST

1 ROUND NEW OAK NOW AVAILABLE



1200mm

FROM \$287

ACTROUND

2 CRESCENT NEW BLACK ACER LEGS NOW AVAILABLE



1200mm

900mm

FROM \$297

ACTCRES

3 ARC FIXED HEIGHT OR BENCH HEIGHT ADJUSTABLE LEGS



1800mm

900mm

600mm

FROM \$352

ACTARC

4 RECTANGLE



1500mm

750mm

FROM \$332

ACT1575

ALSO AVAILABLE IN ERASABLE SURFACE TOPS



IDEAL FOR EDUCATIONAL USE

COMPARE OUR TOP SIZES

Acer tables offer lower "cost per student"... Acer 1200mm diameter tables accommodate 4 students, other 900mm diameter tables accommodate 1 student.

TOP SHAPE	FIXED HEIGHT WITH LEVELLING FEET		HEIGHT ADJUSTABLE WITH CASTORS	
	CODE	PRICE	CODE	PRICE
1A ROUND	ACTROUND	\$287	ACTROUND AW	\$395
1B ROUND WB*	ACTROUND.WB	\$317	ACTROUND AW.WB	\$425
2A CRESCENT	ACTCRES	\$297	ACTCRES AW	\$405
2B CRESCENT WB*	ACTCRES.WB	\$327	ACTCRES AW.WB	\$435
3A ARC	ACTARC	\$352	ACTARC AW	\$460
3B ARC WB*	ACTARC.WB	\$392	ACTARC AW.WB	\$500
4A RECTANGLE	ACT1575	\$332	ACT1575 AW	\$440
4B RECTANGLE WB*	ACT1575.WB	\$362	ACT1575 AW.WB	\$470

FURTHER SAVINGS AVAILABLE

SCAN TO VIEW



EDUCATION RUN-OUT SPECIALS

Core

Extended

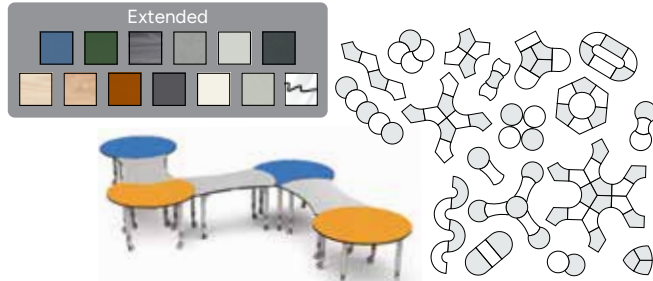

All Acer tops are 18mm thick MDF
*Erasable Surface tops have 12 month warranty

Available Table Frames: (Check specific products to see which frames apply)

F



Fixed Height Leg
(with levelling feet)
720mm high

W

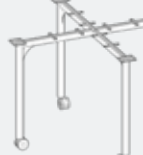

Fixed Height Leg
(with lockable castors)
720mm high

AW



Height Adjustable Leg
(with lockable castors)
6 heights: 550 | 610 | 640 | 680 | 720 | 750mm

FP

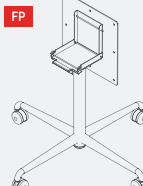

Flip Table
(with lockable castors)
720mm high

B

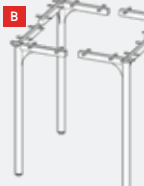

Bench Fixed Height Leg
(with levelling feet)
900mm high

BW

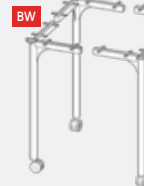

Bench Fixed Height Leg
(with lockable castors)
900mm high

BAW

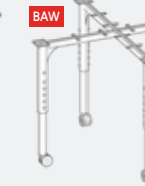

Bench Height Adjustable Leg
(with lockable castors)
6 heights: 720 | 780 | 810 | 850 | 900 | 930mm

The only flip frame suitable for 1200mm tops

Strong 60mm height adjustable leg

Option of heavy duty lockable castors or glides (ACBELLGLIDE)



Flexible ways to Learn!

Ask about approved products

SOA QED
104526

SAVE
UP TO 18%

EDCO CANTILEVER CHAIR AND STOOL

Modern ergonomically designed cantilever chairs absorb the bounce of active children, so teachers don't have to.

The robust seat surface is easy to clean and resists scratches. The C-frame makes raising the chairs on desks and tables quick and safe.

Glides provide stability and protect floors from abrasion.

A convenient grip hole in the seatback makes carrying this lightweight chair effortless.

	GRADE	SEAT HEIGHT	CODE	SUITS DESK HEIGHT (mm)	PRICE
EDCO CANTILEVER CHAIR	3-5	380mm	EDCHC380**	625-700	\$109
	4-6	430mm	EDCHC430*	675-725	\$115
	6-12	460mm	EDCHC460*	725-750	\$119
EDCO 4 LEG STOOL	6-12	660mm	EDSTL660	900	\$149

* Stocked range: Any colour shell on Black Frame

** Stocked range: Charcoal or Yale Blue shell on Black frame

Indent item - lead times apply

Shell colours:

380H CHAIR
\$109

EDCHC380

660H STOOL
\$149

SAVE \$45
EDSTL660

New Lower Prices

BIFMA

7 YEAR WARRANTY

AVAILABLE IN 7 HEIGHTS

LASSO TAPER

RADIUS CORNERS FOR ADDED SAFETY



OPTIONAL CASTORS FOR EASY MANOEUVRABILITY

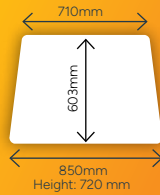

ONLY

\$197

LASTAPER/W

OPTIONAL TOTE (T)
\$23



30% off
Juicy tops
\$136
Save \$61
while stocks last

LASSO TAPER LAYOUT OPTIONS

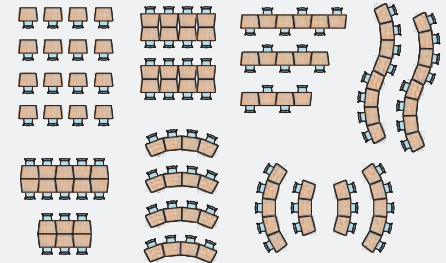

LASSO SHIELD

STANDARD TOP COLOURS:



Extended Top Colours:



FRAME COLOURS:



ONLY

\$172

LASSHIELD/W



7 YEAR WARRANTY

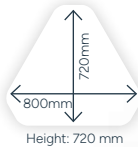

30% off
Juicy tops
\$122
Save \$50
while stocks last

LASSO SHIELD LAYOUT OPTIONS

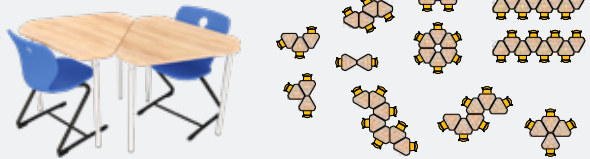

STYLE	LEGS	STATIC	MOBILE	PRICE
SHIELD	3	LASSHIELD	LASSHIELDW	\$172
TAPER	4	LASTAPER	LASTAPERW	\$197
TAPER + TOTE	4	LASTAPERT	LASTAPERWT	\$220

* Prices based on standard Melamine colours ** Erasable surface tops add \$10

SCAN TO VIEW



EDUCATION
RUN-OUT SPECIALS



GROW DESK - 9 HEIGHT POSITIONS

NO TOTE
600 x 450
\$159
GRDKC0604



NO TOTE
600 x 600
\$179
GRDKC0606

TOP	SIZE mm	CODE*	PRICE NO TOTE	PRICE WITH TOTE
SINGLE	600W X 450D	GRDKC0604	\$159	\$179
SINGLE	600W X 600D	GRDKC0606	\$179	\$199
DOUBLE	1200W X 600D	GRDKC1206	\$224	\$299

*Add "T" for TOTE

- Tested and Certified to the Australian Standard
- Height adjustable - 9 positions
- Height range 550 - 750mm
- 18mm environmentally friendly E-Zero top with tamper-proof, moulded PP edging and a strong steel frame



- Optional Grow Tote with rails (pack of 2) suits Grow 1200w desk

NO TOTE
1200 x 600
\$224
GRDKC1206



PLATO CHAIR

Tested to AS/NZS 4610.2 Education Chairs. 180kg Static Load Test. 200,000 Seat/Back Fatigue Test.

- High Impact Polypropylene 1 piece frame
- Back leg angle designed to discourage backward rocking

460 HIGH
\$69
PLCH460L

GRADE	SEAT	CODE	SUITS DESK	PRICE
PREP-1	335	PLCH335	550-600	\$45
PREP-3	355	PLCH355	600-650	\$49
4-6	400	PLCH400	625-725	\$59
6-12	460	PLCH460/L	725-750	\$69
6-12	460	PLCH460LU (WITH SEAT PAD)	725-750	\$89*



- Stackable - 10 High
- Also available in smaller heights 240/260/280/300mm



New colour Pacific Blue



PLATO LINK



The ever popular Plato chair (460mm) is now also available with easy linking feature ideal for school halls, assembly areas, canteens etc.

- Also available chair trolley for easy move and reset (TROLLEY01) \$POA



- Optional seat pad PLCH460LU

QUADRIC FOLD-UP EXAM TABLE



730 HIGH
\$139
QDFTB0805

- 730h x 800W x 550mm D
- 18mm E-Zero top
- Folding frame



Trolley holds 16 tables \$1140 QDFTBR16

ASSEMBLY INCLUDED



PLATO STOOL



2 HEIGHTS
\$119
PLSTxx

- Heights: 370mm or 450mm
- Diameter 330mm
- Base encourages movement

STOOL
\$99
CATO650



- Charcoal only
- Seat height: 650mm
- Splayed legs to minimise potential for tipping
- Stack 7 high

CATO STOOLS



- Seat height: 650mm
- Art, Graphics & Science stool
- Stack 7 high

Also avail. with Ply seat \$80 While stocks last CATO650.OKT

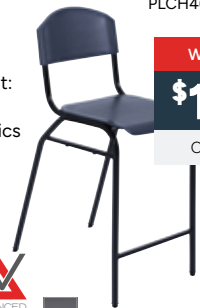

WITH BACK
\$109
CATO650B



CLEARANCE

SAVE UP TO 25%

PODZ CUBEE



ONLY
\$134
SAVE \$45 PDCUBEC

- 470mm wide

PODZ GEO



ONLY
\$314
SAVE \$105 PDGEOC

- 1300mm wide

PODZ FLOWER PACKAGE



THE LOT
\$899
SAVE \$300 PDFLOWER

- 1280mm x 1230mm
- Five heavy duty castors per piece

MIX & MATCH VINYL COLOURS



ONLY
\$49

SAVE \$10 PDLPCENT

PODZ TROLLEY



SAVE UP TO 25%

EXTRA LARGE 610MM DIA. 90MM THICK

TROLLEY \$179 PDLPTROLLEY
• 1120mm high
• Holds 11

PODZ RONDO

- Ball-bearing castors with rubber wheels
- 480mm diameter
- 460mm high

ALSO AVAILABLE IN FABRIC \$POA



WHILE STOCKS LAST SPECIAL

ONLY
\$141
SAVE \$48 PDRONDC

PODZ CENTRIC



- 1120mm wide



ONLY
\$374
SAVE \$125 PDCENTC

Flexible Learning Furniture

Ask about approved products

SOA QED
104526



SATELLITE TEACHERS CADDY

- Large Top 900W x 550D
- Small Top 485W x 500D
- 1070mm high
- With Slide out Worktop
- Routed Handles
- Gang Lock (all locking drawers)
- Heavy Duty Locking Castors
- 2 Standard Drawer + 2 x File Drawers
- Silver "EO" Board with Black Edge or Oak



Erasable surface top

ONLY
\$639
SMALL TOP SATE04



Silver or Oak body with large top **\$719** SATE04T

FUSION LEARNING CENTRE

ONLY
\$659
FUSIONSTD

- Strong paper holder
- Heavy duty locking castors
- Includes rear storage
- Includes magnetic whiteboard
- 830W x 450D x 1560H
- * Tote boxes extra \$20ea TOTE120



STAX EXAM TABLE

ONLY
\$167
STAXTABLEB

3 YEAR WARRANTY



- 720H x 750W x 700 D
- 12mm MDF Top (E1) with heavy duty slimline rod frame
- Available in Diamonds top with Pearl Silver powdercoat frame or Oak top with black frame
- Stackable up to 25 high on a trolley



Stax Trolley STAXTROLLEY **\$200** SAVE \$50



UPTOWN GAS HEIGHT ADJUSTABLE TABLE/ LECTERN



GAS LIFT!



- Lift capacity
- Total load capacity 40kg
- Table top section is 600 x 550mm
- Height adjustable from 750-1150mm
- Tablet groove
- Drink holder
- Lockable castors

ONLY
\$299
UPTB0605
NEW



STEAMROLLER TABLE

IDEAL FOR MAKER SPACE - 1800 X 1200



- Fixed height 1040mm
- Erasable surface
- Stores 15 totes
- Other configurations available

INC 15 TOTES
\$1345
SRBE1812T15/TOTES



Steamroller Table with Height adjustable leg **\$750** SRTA1812AW

STOREWELL TOTE TROLLEY

10 TOTE - DOUBLE 820W X 460D X 920H
15 TOTE - TRIPLE 1250W X 460D X 920H



10 CLASSIC INC TOTES
\$539
STCTOTR10.SV/TOTES

- Heavy duty locking castors
- E-Zero MDF carcass (Silver or Oak)
- Packages include tote boxes
- Mix and match Classic or Maxi totes

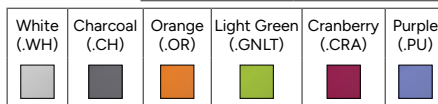

CLASSIC TOTES 420W x 365D x 120H TOTE120.xx
MAXI TOTES 420W x 365D x 270H TOTE220.xx

15 CLASSIC INC TOTES
\$759
STCTOTR15.SV/OK TOTES

CEO LECTERN & XO MOBILE RESOURCE CENTRE



ONLY
\$289
CEOL01

- Extra Shelf
- LED Lamp (Batteries Inc)
- Locking Castors

3 YEAR WARRANTY

SMALL
\$339
XOESC01

- Steel handle
- 598W x 450D x 1000H
- Lockable single drawer and door



MOBILE WHITEBOARDS



- Double sided • Sturdy frame
- 1750mm overall height

1200W x 1000H

\$299

TSMWB1210

1500W x 1000H

\$369

TSMWB1510

3 YEAR WARRANTY

1800W x 1000H

\$399

TSMWB1810

MAGNETIC DESIGNER GLASS BOARD



- Lifetime stainfree surface
- 4mm safety toughened glass
- 8 times stronger than glass

SIZE	PRICE	CODE
900W x 600H	\$219	TRRLGB0906
1200W x 900H	\$479	TRRLGB1209
1500W x 900H	\$579	TRRLGB1509
1500W x 1200H	\$679	TRRLGB1512
1800W x 900H	\$659	TRRLGB1809
1800W x 1200H	\$759	TRRLGB1812
2100W x 1200H	\$859	TRRLGB2112
2400W x 1200H	\$979	TRRLGB2412

ALSO AVAILABLE IN BLACK BACKED SURFACE

1200W x 600H	\$409	TRMG1206B
1800W x 1200H	\$989	TRMG1812B

COMMUNICATE ROOM DIVIDER



ONLY

\$749

COMD02

3 YEAR WARRANTY

- 900W x 1800H
- Each Divider can be linked together with the Connector Kit COMD01 **\$29**
- Side 1 - magnetic whiteboard with magnetic pen shelf and adjustable flipchart pad hooks
- Side 2 - pinnable charcoal fabric
- 90mm locking castors

WALL MOUNT WHITEBOARD

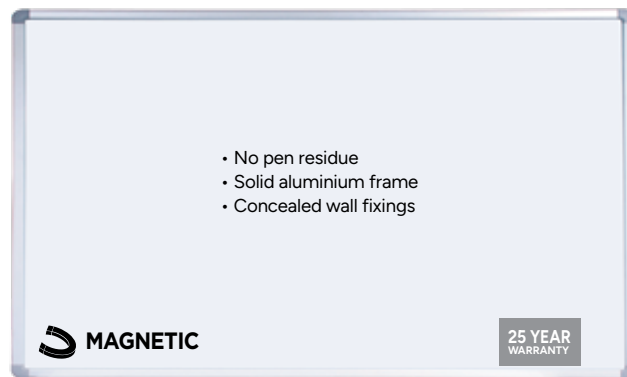

- No pen residue
- Solid aluminium frame
- Concealed wall fixings

MAGNETIC

25 YEAR WARRANTY

COMMERCIAL GRADE 3YR WARRANTY

900W x 600H	\$79	TSWB0906
1200W x 900H	\$129	TSWB1209
1500W x 900H	\$169	TSWB1509
1800W x 900H	\$199	TSWB1809
1800W x 1200H	\$249	TSWB1812
2400W x 1200H	\$299	TSWB2412
3000W x 1200H	\$369	TSWB3012

PORCELAIN SURFACE 25YR WARRANTY

\$119	TRRLPWW0906	Porcelain surface (vitreous enamel) whiteboards are ideal for heavy duty use such as schools, conference centres and medical facilities
\$209	TRRLPWW1209	
\$309	TRRLPWW1509	
\$359	TRRLPWW1809	
\$389	TRRLPWW1812	
\$509	TRRLPWW2412	
\$649	TRRLPWW3012	

WASTE PAPER BIN

ONLY

\$29

TECH08



CITI FREE STANDING PANEL SCREEN

1200H		
750W	\$324	CTFS1275.CH
1200W	\$384	CTFS1212.CH
1500W	\$424	CTFS1215.CH
1800W	\$474	CTFS1218.CH

1500H		
750W	\$334	CTFS1575.CH
1200W	\$434	CTFS1512.CH
1500W	\$494	CTFS1515.CH
1800W	\$554	CTFS1518.CH

ONLY

\$324

CTFS1275.CH

- Silver Fabric/Black Frame
- Black Fabric/White Frame

FELT PINBOARDS



- Strong extra thick felt
- Wall fixings supplied
- Available in Blue or Grey

3 YEAR WARRANTY

900W x 600H	\$69	TSPB0906
1200W x 900H	\$119	TSPB1209
1500W x 900H	\$159	TSPB1509
1800W x 900H	\$169	TSPB1809
2400W x 1200H	\$299	TSPB2412

BLOK SCREENS

FROM
\$289
SAVE \$40
BLOK1515



3 YEAR WARRANTY

1500H x 1500W	\$289	BLOK1515
1500H x 1800W	\$319	BLOK1518
1800H x 1500W	\$319	BLOK1815
1800H x 1800W	\$349	BLOK1818

• 50mm thick • Pinnable surface

Largest Selection of Mesh Office Chairs

Ask about approved products

SOA QED
104526

ERGOFORM

INC. ARMS
\$259

BLACK BASE
ERGF22M

OPTIONAL
POLISHED
BASE
ADD \$60
ERGF22P

10 YEAR
WARRANTY



- Full ergo 3 lever mechanism
- Tilt tension control
- Adjustable arms
- Adjustable height back

FLOW

NO ARMS
\$329

FLOW23

OPTIONAL
ADJUSTABLE
ARMS
ADD \$90
ARMKIT29

10 YEAR
WARRANTY

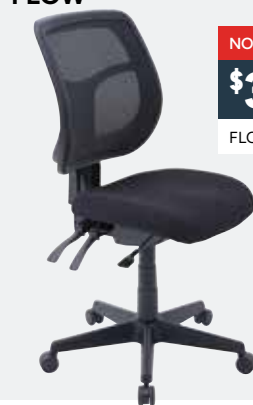

- Adj ratchet back/lumbar
- Independent tilting seat/back
- Black mesh back

THE MET

FLOW & MET
TESTING

Tests based on AS/
NZS 4438 (Level 6)
Height Adjustable
Chairs
259kg Static Load Test
320,000 Cycles -
Back Test
300,000 Cycles -
Seat Test
Tests assume user
weight of 140kg

EXECUTIVE
\$459

ARMS INCL.
METT12

10 YEAR
WARRANTY

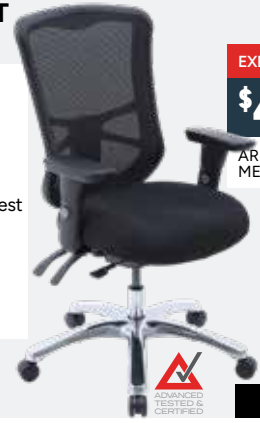

- Fully ergonomic 3 lever mechanism
- Ratchet back • Adjustable arms
- Polished aluminium base

ABIGAIL

MED BACK
\$169

ABIG14

3 YEAR
WARRANTY



- Ideal meeting chair
- Single position tilt lock
- Black mesh back with black fabric seat

STRIDE

MED BACK
\$179

STRD24.BKE2

3 YEAR
WARRANTY



- Mesh back/fabric seat
- Generous seat
- Single position tilt lock with tension control

PEDRO

NO ARMS
\$219

PEDR23

OPTIONAL
T- ARM
(FIXED
HEIGHT)
\$50
ARMKIT20

5 YEAR
WARRANTY



- Fully Ergonomic (tilting seat & back)
- Moulded foam seat
- Black, Red, Blue, Lime & Orange

ONLY
\$289

WORKMSHA

5 YEAR
WARRANTY

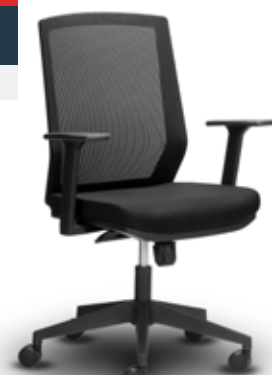

- Synch Mech
- Modern plastic perforated backrest
- Fully adjustable arms

NERVA BOARDROOM CHAIR

ONLY
\$309

NERV11.BK

10 YEAR
WARRANTY

- 135kg max user weight
- Fixed height
- Generous seat size (505x450mm)
- Single position lock height adjustment using sleek steel handle
- Self-weighted mechanism with alloy rocker box
- Single piece shell with fixed arms



ADJUSTABLE ARMS

LINEAR

MED BACK
\$309

LINE14M

- Black mesh with fabric seat

SYNCHRO
MECHANISM

5 YEAR
WARRANTY



OPTIONAL
POLISHED BASE
ADD \$60
LINE12MP/14MP

HEAD REST
OPTION
ADD \$40
LINE12M/P



PROMAX

SYNCHRO
NO ARMS
\$339

PMAX23SY

- Smooth synchronised action

OPTIONAL
ADJUSTABLE
ARMS
\$90
ARMKIT29

5 YEAR
WARRANTY

*While stocks last

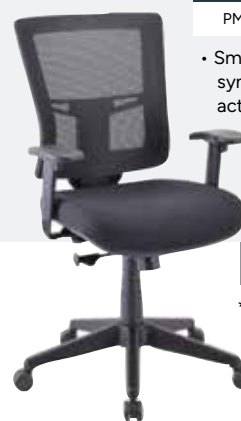

- Ratchet back
- 60mm castors
- Ergonomic independent seat and back tilt
- High arch base
- Black mesh back

IDEAL
PROJECT
CHAIR

3 LEVER NO
ARMS
\$369

PMAX233

5 YEAR
WARRANTY



*While stocks last



Mesh Office Chairs

OLIVIA

BLACK

\$369

OLIV14

5 YEAR WARRANTY



• Padded lumbar support

- Synchro Mechanism with 4 position lock
- Seat Slide
- Adjustable Arms

WING

ADJ. HEADREST

\$479

BLACK WING12H

3 YEAR WARRANTY



• Adjustable lumbar support with added foam

- Synchronised mechanism with "weight balance"
- Adjustable height lumbar support
- 4 position tilt lock
- Adjustable height PP arms

A-TEAM

NO ARMS* **\$379**

WITH ARMS* **\$469**

SAVE \$20 ATEAM11.BK

SAVE \$20 ATEAM12.BK

10 YEAR WARRANTY



• Adjustable lumbar support

• Height adjustable arms

• High density foam

- *Priced in Black All Over
- Mesh back available in Black/Red/Blue/Green (\$POA)
- Seat available in many colours (\$POA)

Ask about upgrade to the Super-Heavy Duty Model

160kg

ATEAM11/12HD

• Standard 135kg weight rating



A sample has been tested by AFRDI

MANY Colours available POA

NAME	CODE	NO ARMS	ARMS
TEAMSTAR	TEAMS11/12	\$309	\$399
SYNC A-TEAM IN BLACK	ATEAMSYN11.BK/12.BK	\$319	\$409
A TEAM IN BLACK	ATEAM11.BK/12.BK	\$379*	\$469*
A-TEAM RATCHET	ATEAMRCH11/12	\$409	\$499
A-TEAM HEAVY DUTY	ATEAMHD11/12	\$489	\$579

THE HUM ELITE 2 HIGH BACK CHAIR

2024 MODEL

ERGONOMIC **\$849**

EXECUTIVE **\$599**

SAVE \$50 ERHU12E



• Adjustable arms

• Heavy duty alloy 5 star base

• Synchronised mechanism - lockable in 5 positions

• Height / tilt adjustable headrest

• Height adjustable backrest

• Tilt adjustable lumbar support

5 YEAR WARRANTY

SGS BIFMA GREENGUARD

- Adjustable seat height/ seat slider/ seat recline
- Back and seat forward tilt adjustable
- 12 zones individual mesh support

ERGOFIT

• Adjustable lumbar support

ERFIT12M

• Height/tilt adjustable headrest

5 YEAR WARRANTY



BIFMA

- High density moulded foam
- Ratchet back height adjustable
- 3D adjustable arms
- Polished aluminium base
- Synchronised mechanism - lockable in 4 positions

ZONE 2 OPERATOR

ERGONOMIC **\$599**

EROZ24E

5 YEAR WARRANTY



SGS BIFMA GREENGUARD

- 3 position locking synchro mech
- Adjustable arms (height, angle, forward & backward)
- Stealth tension adjustable lumbar support
- 8 zone individual mesh support

ZEUS

BLACK **\$439**

ZEUS14.BK

GREY **\$499**

ZEUS14.GY

10 YEAR WARRANTY



• Tension adjustment for chair reclining

• Full mesh, one-piece back and seat in grey (alloy base) or black (nylon base)

- Tension adjustment for chair reclining
- Full mesh, one-piece back and seat in grey (alloy base) or black (nylon base)

SOLIDWORX - AUSTRALIA'S TOUGHEST TRAINING CHAIR

NO ARMS **\$309**

WITH ARMS **\$349**

RIGHT TABLET **\$409**

SWRX61W.BK

SWRX62W.BK

SWRX63W.BK

3 YEAR WARRANTY



- Common features:
- Plastic back • Stackable
 - Foldable seat for nesting
 - Iron tube leg and PU castor
 - Simple and effective linking feature
 - All components meet BIFMA standard
 - Greenguard Certified
 - Approved for Government use DET 68449 SOA

- Foldable arm rest and tablet
- Tablet on RHS, Size 330W x 260D



LINKING KIT \$30 SWRXLINK



STACKING TROLLEY \$279 SWRX66.BK

Operator Chairs

Ask about approved products

SOA QED
104526

ERGOFORM

WITH ARMS

\$279

BLACK BASE
ERGF22M

Features:

- Tilt tension control
- Full ergo 3 lever mechanism
- Adjustable height back
- Adjustable arms
- Black fabric or Black mesh



ALSO AVAILABLE
IN MESH
\$259

OPTIONAL
POLISHED
BASE
ADD **\$60**
ERGF22P



10 YEAR
WARRANTY

Tested to BIFMA
X5.1 - to 125kg
540,000 cycles
(Tilt Mech Test)
140,000 cycles
(Seat Durability
Test)
60,000 cycles
(Arm Durability
Test)

PU LAB STOOL

HEIGHT RANGE:
340-580mm

A1

IMPROVED
MECHANISM



B2

HEIGHT
RANGE:
560-820mm

	STYLE	CODE	PRICE
A1	SADDLE	LABSTO2	\$199
A2	SADDLE (with Drafting Kit)	LABSTO2D	\$239
B1	CHAIR	LABCH23	\$289
B2	CHAIR (with Drafting Kit)	LABCH33	\$349

- Features:
- High quality moulded PU
 - Hard wearing and easy to clean

**STRENGTH
DURABILITY
STABILITY**

**CERTIFICATION
= REDUCED RISK
= PEACE OF MIND**

STANDARDS
AUSTRALIA

NATA SGS



A sample
has been
tested by
AFRDI



CONNECTION RANGE

MED BACK

\$209

SAVE \$20
BLACK
CONX23

HIGH BACK

\$269

BLACK
CONX21

TILTING
BACK &
SEAT
GAS LIFT



TILTING
BACK &
GAS LIFT



- High back available in Black & Navy fabrics

ADJUSTABLE ARM
ADD **\$90** ARMKIT50
FIXED LOOP ARM KIT
ADD **\$50**
ARMKIT12



DRAFTING KIT
ADD **\$130**
DRAFT91



EX HIGH BACK

\$289

CONX27

3 LEVER MECHANISM
LARGE SEAT
INDEPENDENT SEAT/
BACK TILT

5 YEAR
WARRANTY



MAYFIELD

MED BACK

\$179

SAVE \$10
MAYF23

STANDARD ARMS
ADD **\$50**
ARMKIT12



3 YEAR
WARRANTY

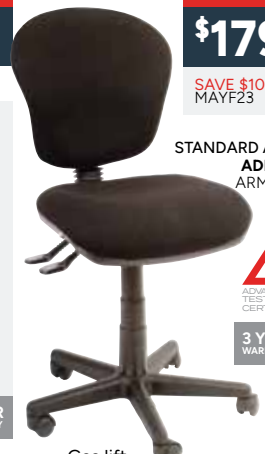

- Gas lift
- Tilting back
- Height adj back
- Black fabric

EXECUFORM

WITH ARMS

\$499

EEXF22



10 YEAR
WARRANTY



JEMMA

FABRIC

LEATHER LOOK

\$349 **\$409**

NO ARMS
JEM21

NO ARMS
JEM21

OPTIONAL ARM
KIT ADD **\$90**
ARMKIT18



10 YEAR
WARRANTY



AS SHOWN
WITH ARMS
\$499

- High density foam
- Adjustable arms
- Extra large moulded seat/back
- Independent back & seat tilt
- Available in Black fabric

- Fully ergonomic
- Independent tilting seat and back
- Steel base
- Black fabric or Black Leather-Look (PU)

CHAIR ACCESSORIES DON'T FORGET YOUR CHAIR MAT!

SMALL

\$89

915 X 1220MM
WITH ANCHORS
CHAX01

LARGE

\$109

1350 X 1150MM
WITH ANCHORS
CHAX02

DIPLOMAT

\$159

1220 X 1525MM
WITH ANCHORS
CHAX03

HARD FLOOR

\$149

1150 X 1350MM
WITH ANCHORS
CHAX04

**NOW 20% THICKER
EXTRA THICK: AVOIDS
CRACKS & DENTS**

Executive Chairs

EMERALD

HIGH BACK

\$239

EMER12

3 YEAR WARRANTY

- Black leather look (PU)
- Padded arms
- Single position tilt lock mechanism



ARLINGTON RANGE

HIGH BACK

\$359

ARLN12

3 YEAR WARRANTY

- Knee tilt mechanism
- Multi position lock
- Black leather-look PU
- Chrome polished arms & base



CANTILEVER

\$259

ARLN46

5 YEAR WARRANTY

- Cantilever base



BETA

HIGH BACK

\$269

BETA12

3 YEAR WARRANTY

NEW & IMPROVED PU

- Single position tilt lock
- Black leather look (PU)
- "Flip-Away" arms



BETA

MESH

\$269

BETA12

3 YEAR WARRANTY

- Slate mesh white frame
- Single position tilt lock
- "Flip-Away" arms



MARRIOTT

HIGH BACK

\$339

MARR12

3 YEAR WARRANTY

NEW & IMPROVED PU

- Black leather look (PU)
- Single position tilt lock



HEAVY DUTY CHAIRS

BROADBEAM

ONLY

\$639

BROAD12

3 YEAR WARRANTY

NEW & IMPROVED PU

RATED TO 200kg

- Super strong construction for the larger body type with extra large seat (620W x 520D)
- Finished in very soft leather-look PU
- Polished aluminium base and arms



BIG MAN

ONLY

\$789

BIGM12.BKLE

5 YEAR WARRANTY

RATED TO 200kg

REAL LEATHER

- Extra large seat (560W x 480D)
- Genuine leather seat & back
- Tilt lock • Fixed padded arms
- Large seat • Steel base



TEXAS 200

LEATHER-LOOK PU

\$699

TEXAS200HD.BKPU

5 YEAR WARRANTY

RATED TO 200kg



- 200kg user weight rating
- BIFMA approved
- Simple 100mm gas strut mechanism
- 35-50mm high density foam
- Reclining arm rests
- Steel 700mm dia base with PA castors



TEXAS 200

MESH

\$699

TEXAS200HD.BK

5 YEAR WARRANTY

RATED TO 200kg



- 200kg user weight rating
- BIFMA approved
- Simple 100mm gas strut mechanism
- 35-50mm high density foam
- Reclining arm rests
- Steel 700mm dia base with PA castors



Boardroom Chairs

Ask about approved products

SOA QED
104526



CHARTER RANGE

HIGH BACK
\$289

CHART12

- HB = 630mm high
- Black leather-look (PU) upholstery
- MB = 490mm high
- Black mesh finish



MID MESH
\$259

CHART14M



MID BACK
\$259

CHART14

• MB = 490mm high

3 YEAR WARRANTY



- Removable arm padding
- Chrome base and arms
- Single position tilt lock mechanism

PILBARA BOARDROOM

THICK PAD
\$399

PILB14MBT

SLIM PAD
\$389

PILB14MBS



ALSO AVAILABLE THICK PAD HIGH BACK
\$449
PILB12HBT



ALSO AVAILABLE SLIM PAD HIGH BACK
\$419
PILB12HBS

- Thick pad/thin pad
- Classic retro design with all black frame
- Tilt lock with tension control

Black PU

SAVE UP TO 38%

ROXBY MEETINGSTANDARD

BUY WITH CONFIDENCE
BEWARE OF CHEAP IMITATIONS

- Interchangeable seat, base and arm options
- 4 star base available in Black, White & Polished Alloy
- Adjustable height
- Large comfortable seat 450W x 420D
- High quality aluminum
- Ezi Rolling rubber castors, also suitable for soft floors



Optional With Arms
\$319
ROXB62S

Chair Colours

- Tan PU
- Black PU
- Forest Green PU
- Mahogany PU
- Navy PU
- Charcoal PU
- Grey Fabric
- Olive Fabric

Base Colours

- Black
- White
- Polished Alloy

NO ARMS
\$259

SAVE \$130
ROXB61S

5 YEAR WARRANTY

SAVE UP TO 38%

ROXBY MEETING DELUXE WITH TILT



Optional With Arms
\$349
ROXB62D

- Large comfortable seat 450W x 420D
- Tilting mechanism
- 5 star base • Gas lift
- High quality aluminum
- High quality DONATI mechanism
- Ezi Rolling rubber castors, also suitable for soft floors

NO ARMS
\$299

SAVE \$130
ROXB61D

5 YEAR WARRANTY

SCAN TO VIEW



RUN-OUT SPECIALS

ROXBY SLED



ONLY
\$199

SAVE \$120
ROXB71SL

5 YEAR WARRANTY

- Large comfortable seat 450W x 420D
- Solid steel frame

ROXBY SLED BASE STOOL



- 780mm seat height
- Solid steel frame

ONLY
\$239

SAVE \$80
ROXB01ST

5 YEAR WARRANTY

MYSTIQUE CHAIRS

VISITOR CHAIR

\$179

SAVE \$30
LUX-MYS01B

- Upholstered in velvet fabric
- Black painted metal frame

Gold painted metal frame LUX-MYS01G

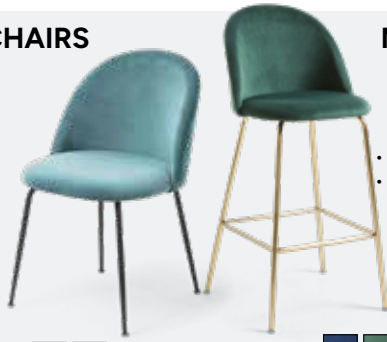

MYSTIQUE STOOLS

- Fully upholstered
- Gold painted metal frame

Black painted metal frame
LUX-MYS980B

BAR STOOL

\$259

SAVE \$40
LUX-MYS980G



SPICER



'CLOUD' FABRIC
500W x 610D (SPIC)
FROM **\$289**

SALISBURY



'DENIM' FABRIC
570W x 620D (SALB)
FROM **\$319**

SALISBURY XL



BLACK VINYL
670W x 740D (SALBXL)
FROM **\$419**



METAL 4 LEG - BLACK
SPIC650/750 **\$349**
METAL 4 LEG - TIMBER
SPIC750 **\$359**



METAL 4 LEG - BLACK
SALB650/750 **\$389**
METAL 4 LEG - TIMBER
SALB750 **\$399**

STANDARD MODEL INCLUDES FABRIC AND 4 LEG METAL BASE (BLACK)	
FINISH	ADD
4 FABRICS (Warwick Gravity) Denim, Navy, Slate, Steel	-
4 LEATHER GRAIN LOOK FABRICS (Warwick Eastwood) Bisan, Donkey, Slate, Tan	-
3 LEATHER LOOK FABRICS (Warwick Pelle) Navy, Sage, Tan	\$20
Custom fabrics available \$POA	
VINYL (V) Black	-
4 LEG METAL (4LM) - Black	-
4 LEG METAL (4LM) Lt. Oak, Dark Walnut, Lt. Walnut, Birch	\$10
4 LEG TIMBER (4LT) Lt. Oak, Lt. Walnut	\$100

HUEY TUB



- Available in Warwick Pelle Fabric (Add \$20)
- Many frame styles available \$POA
- Metal shell frame with moulded foam seat.



ONLY

\$379

WARWICK GRAVITY SLATE FABRIC ON CROSS-SLED BASE HUEYCSL

CADIA 5-STAR



ONLY

\$579

CADIA5C

5 YEAR WARRANTY

- Height adjustable seat
- Steel 5-star castor base
- Foam seat cushioning
- 140kg weight limit



CADIA 4-LEG



ONLY

\$579

CADIA4L

5 YEAR WARRANTY

- 140kg weight limit
- Foam seat cushioning
- Black or White powder coated steel frame
- Cushioning backed by steel frame

NOISE REDUCING ACOUSTIC WALL PANNELLING

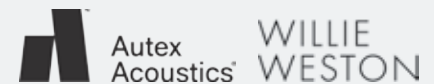

Uniting contemporary First Nations design and acoustic functionality, the Autex Acoustics™ x Willie Weston collection has been curated for education, government and commercial spaces.

Locally manufactured on Cube™ and Quietspace® Panel, the range is comprised of eight designs in 21 colourways and is entirely carbon neutral.

The specification of each design contributes to fair and equitable income for each artist via Willie Weston, a profit-for-purpose business working in partnership with First Nations artists to support the integration of contemporary First Nations design into the built environment.

PLEASE CONTACT US FOR A CUSTOM QUOTE

Features:

- Carbon neutral
- NRC 0.45 - 0.85
- Available in 6mm, 12mm, 24mm, and 25mm thicknesses
- Available in 2400mm, 2700mm, and 3000mm lengths
- Group 1 fire rating
- Safe, water-based, UV cured ink
- Locally manufactured in Australia

THE COLLECTION



Durrmu (KK) "Berry"



Jilamara "Sand"



Native Seeds "Olive"



Pandarus "Eucalypt"



Sugarbag Dreaming "Ghost Gum"



Sugarbag Dreaming "Saltbush"



Syaw (Fish Net) "Woolybutt"



Water Levels "Marine"



Wak Wak "Storm"

Visitor Chairs

Ask about approved products

SOA QED
104526

"SIDEKICK" SWIVEL STOOL

WITH RING

\$199

SIDE02

NOT SHOWN
NO RING
\$119
SIDE01

3 YEAR WARRANTY



- 400mm Dia seat
- Seat height 550mm to 750mm
- Black leather look PU seat
- Chrome finish base with gas lift

POLY STACKER



ONLY

\$79

SAVE \$10
UCPP481



3 YEAR WARRANTY

- Strong steel frame
- Available in Black only

STRATA STACKER



ONLY

\$89

SSRA61



5 YEAR WARRANTY

- 2 standard fabrics, Blue or Black

MARVIN



ONLY

\$129

MARV71.BK

3 YEAR WARRANTY

- Steel black powder coated sled frame
- Stackable

BERLIN VISITOR



ONLY

\$129

BBER44

3 YEAR WARRANTY

- Cantilever
- Chrome frame
- Black Vinyl

ZOOM RANGE



NO ARMS

\$169

ZOOM61

3 YEAR WARRANTY

WITH ARMS
\$179
ZOOM62

SLED BASE
\$199
ZOOM71

- Strong, chromed-steel frame
- Mesh back with Black fabric seat



3 YEAR WARRANTY

LONDON RANGE



BLACK FRAME
BLACK FABRIC

\$169

LLON44B

3 YEAR WARRANTY



CHROME FRAME
BLACK FABRIC

\$199

LLON44C

- Black frame with arm pads
- Black fabric seat and back
- Chrome frame + arm pads
- Black leather-look (PU)

G20 MEETING



4 LEG

\$169

G20LEG

3 YEAR WARRANTY



- Stackable (4 high)
- Polypropylene arms
- Solid steel frame
- Black mesh back and Black (E2) fabric seat

ANGIE VISITOR



ONLY

\$189

ANGE44

3 YEAR WARRANTY

- Chrome cantilever frame
- Matches many executive chairs
- Black leather-look (PU)

SONAR CANTILEVER



MESH

\$199

SONA72

5 YEAR WARRANTY

- Cantilever Chrome Frame
- Square Fixed Arms
- Mesh Back

KONFURB HARMONY



ALLOY BASE

\$429

HARM21.WH

5 YEAR WARRANTY



NYLON BASE
\$429
HARM21.BK

- Height adjustable seat
- Contoured polypropylene moulded shell
- Superior comfort & dynamic seat movement

Training & Breakout Chairs

MIXX 'N' MATCH

THE MIXX RANGE

Australia's most versatile range of high quality breakout visitor seating.

	BASE STYLE	CODE	DETAIL (ALL PRICES PLASTIC SHELL)	PRICE
A	4 LEG	MIX61xx	Metal frames options	\$159
B	SLED	MIX71xx	Chrome/Black/Woodgrain	\$159
C	4 LEG TIMBER	MIX61Tx		\$149
D	STOOL (630 or 760H)	MIX630x/760x	Black or Chrome frame	\$209
E	TIMBER LEG STOOL	MIX630Tx/760Tx	Black or Chrome foot ring	\$239
F	5 STAR BASE	MIX13x	Black nylon, gas lift and castors	\$219
G	UPHOLSTERED SEAT	Optional Upgrade	Warwick gravity fabric	ADD \$90
H	FULLY UPHOLSTERED	Optional Upgrade	Warwick gravity fabric	ADD \$250
I	ARMS	Optional Upgrade	Lt.Grey/Black/White	ADD \$40

VARIETY OF LEGS AND ARMS OPTIONS

- Plastic shell only

MANY Colours available PCA



SEE THE FULL RANGE IN OUR MIXX CATALOGUE AT:
empirefurniture.com.au

PEEKABOO STOOL

ONLY \$75

SAVE \$10 PEEK01

12 STACKABLE

- Size: 400W x 410D x 467Hmm
- IF Design Award winner 2020
- Solid and lightweight design
- Open backrest for easy handling

1 YEAR WARRANTY



SPECTRUM CAFÉ CHAIR

ONLY \$89

SAVE \$10 SPEC61

A sample has been tested by AFRDI

3 YEAR WARRANTY



10 VIBRANT COLOURS

- Static seat load tested to 250kg
- Suitable for indoor or outdoor use
- Stackable
- Approved for Government use DET 68449 SOA

VIRGINIA BAR STOOL

METAL FRAME

\$109

VIRG01

3 YEAR WARRANTY

TIMBER FRAME

\$149

VIRG0IT



- Seat height 760mm
- Overall height 820mm
- Oak coloured timber or black metal leg
- Polypropylene Seat
- Great for Kitchen and Bar areas
- Available in Black & Grey

VERVE RANGE

PLASTIC STOOL

\$159

NO ARMS VERS61F

5 YEAR WARRANTY

- Chrome frame
- 762mm seat height
- Black plastic seat and back
- Fully assembled

PLASTIC

\$99

NO ARMS VERS61P

10 YEAR WARRANTY

- Tested to AS/NZS 4688
- Fixed Height Chairs

FABRIC

\$159

NO ARMS VERS61F

10 YEAR WARRANTY

- 160kg Static Load Test
- 100,000 Seat/Back Fatigue Test

FABRIC WITH TABLET

\$219

NO ARMS VERS63F

10 YEAR WARRANTY

Choice of left or right tablet
VERS63xLxx
VERS63xRxx

PLASTIC WITH TABLET

\$159

NO ARMS VERS63P

10 YEAR WARRANTY

VERVE TROLLEY \$100 VERS66

- Holds 10 x Fabric or 20 x Plastic

Built Strong Steel Storage

Ask about approved products

SOA QED
104526

ALL-STEEL MOBILE PEDESTAL

ONLY \$189
MPBS2DF
10 YEAR WARRANTY

LOCKABLE



Standard Size

Built Strong

- 590H x 390W x 500D
- Fully assembled
- 2 drawers plus file
- Heavy duty ball bearing runners on file drawer
- White, Graphite Ripple or Black Satin

BUILT STRONG MINI MOBILE PEDESTAL

NEW ONLY \$199
MPBS1DF
10 YEAR WARRANTY

LOW & SLIM SPACE SAVING DESIGN



Mini Size

Built Strong

- 525H x 300W x 500D
- Fully assembled
- 1 drawer plus file
- Heavy duty ball bearing runners on file drawer
- White or Black Satin

SUITABLE FOR HEIGHT ADJUSTABLE DESKS

CITI MOBILE PEDESTAL

ONLY \$229
CTMP2DF
10 YEAR WARRANTY



Built Strong

- 597H x 390W x 500D
- Lockable • 2 drawer plus file
- 4 colour handles - Green, Red, Blue or Black
- Heavy-duty ball-bearing runners on file drawer

CITI MONITOR SINGLE ARM

ONLY \$139
CTARM01



Built Strong

- 442mm arm reach
- Height adjustment 400mm height range
- 80° up/down tilt
- 90° left/right pan
- Quick release for easy screen removal
- 75mm or 100mm VESA compatible
- Weight Capacity 15kg per arm
- Colours: Silver, White or Black

CITI MONITOR DOUBLE ARM

ONLY \$239
CTARM02

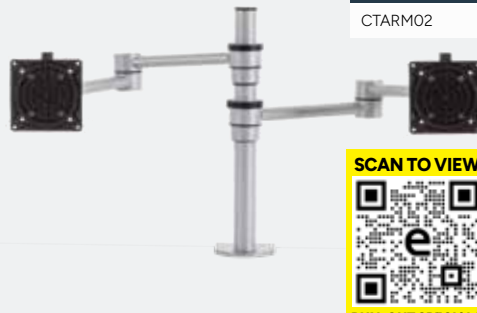

SCAN TO VIEW



RUN-OUT SPECIALS

Built Strong



ONLY \$299
CTARM01L

Built Strong



CLEARANCE
*While stocks last

CITI CPU HOLDER \$39 CTAC09.WH

- Lockable castors
- Max PC: 210mm W



LATERAL FILING CABINETS

- 2 Drawer - 720H x 900W x 460D
- 3 Drawer - 1010H x 900W x 460D
- Fully assembled
- Anti tilt
- Available in White or Black Satin
- Graphite Ripple still available while stocks last



2 DRAWER \$579
LFBS2D

3 DRAWER \$689
LFBS3D

10 YEAR WARRANTY **Built Strong**

WOULD YOU LIKE FILES WITH THAT?

\$70 inc GST ENSF50

- Box of 50 files
- Made from 100% recycled board
- Smooth runners for quiet gliding of files



PIGEON HOLE UNITS

40 HOLE \$549
PHBS40

20 HOLE \$399
PHBS20



- 20 hole, 1010H x 1040W x 385D
- 40 hole, 1827H x 1040W x 385D
- White & Graphite Ripple
- All steel construction

10 YEAR WARRANTY **Built Strong**

Australia's Toughest Steel Storage

FILING CABINET



4 DRAWER
\$399
1300mm H
FCBS4D

3 DRAWER
\$369
1010mm H
FCBS3D

2 DRAWER
\$299
710mm H
FBS2D

10 YEAR WARRANTY

Built STRONG

A sample has been tested by AFDC



LOCKERS (SILVER GREY)



305 Wide

380 Wide

INFINITE LOCKERS



WE DO CUSTOMISED LOCKERS!

3 YEAR WARRANTY

- 460W x 620D
- Fully assembled
- Full extension ball bearing runners
- 4 durable powder coat colours: Graphite Ripple, White, Grey & Black Satin

STYLE	SIZE	CODE	LATCH LOCK	KEY LOCK
Single Door	305W X 1827H X 460D	LKBS301/K	\$219	\$224
2 Door	305W X 1827H X 460D	LKBS302/K	\$229	\$239
4 Door	305W X 1827H X 460D	LKBS304/K	\$239	\$259
Single Door	380W X 1827H X 460D	LKBS381/K	\$229	\$234
2 Door	380W X 1827H X 460D	LKBS382/K	\$239	\$249
4 Door	380W X 1827H X 460D	LKBS384/K	\$249	\$269

• Also available in banks of 2 or 3

STYLE	CODE	PRICE
Single Door	INFMLLOCK1D	\$429
2 Door	INFMLLOCK2D	\$499
3 Door	INFMLLOCK3D	\$569
4 Door	INFMLLOCK4D	\$629
Step Door	INFMLLOCKSTEP	\$559

- 305W x 455D
- Available in White or Natural Oak
- Includes 2 keys per lock
- Soft close hinges
- MDF doors with clear sealant on vent cutouts
- Digital lock available with private or public lock programming **\$79 INFLOCK.BK**

4 SHELVES METAL STATIONERY CUPBOARDS

\$459

2100mm H
SCBS21

3 SHELVES

\$369

1827mm H
SCBS18

2 SHELVES

\$289

1010mm H
SCBS10



10 YEAR WARRANTY

EXTRA SHELF (INCLUDING CLIPS)
\$35 SCBS18

- 905W x 460D
- Adjustable shelves
- Three point locking mechanism
- Priced in White, Graphite Ripple & Silver Grey



INDUSTRIAL STEEL SHELVING

ONLY
\$359

SSBS21.SG



2100mm H

10 YEAR WARRANTY

- 4 adjustable shelves
- 2100H x 905W x 460D
- Silver Grey



INDUSTRIAL QUALITY LONG SPAN SHELVING

INITIAL
\$759

1900mm H
LSBS18I

EXTENSION
\$459

950mm W
LSBS09E



10 YEAR WARRANTY

- High quality all steel construction
- Massive 350kg per shelf capacity
- Supplied with 2 adjustable shelves and 2 fixed shelves as standard

2100H X 600D		
STYLE	CODE	PRICE
1000W Initial	LSBS09	\$559
950w Extension	LSBS09E	\$459
1900W Initial	LSBS18I	\$759
1850W Extension	LSBS18E	\$659
EXTRA ADJUSTABLE SHELF (PACK OF 2)		
STYLE	CODE	PRICE
900W	LSBS09A	\$150
1800W Extension	LSBS18A	\$230

Built Strong Tambour Door Cupboards

Ask about approved products

SOA QED
104526

**NEW AND IMPROVED
GERMAN-ENGINEERED
DOOR SYSTEM**

- Fully assembled
- 900W or 1200W
- Lockable
- Adjustable shelves included
- Available in Black or White
- Attractive roller shutter doors, retract inside the cabinet
- Extra Shelf 900W or 1200W **\$35**
TDBSSH09/12



1200W
\$1049
2000mm H
4 SHELVES
TDBS20H12W

1200W
\$759
1200mm H
2 SHELVES
TDBS12H12W

1200W
\$669
1016mm H
2 SHELVES
TDBS10H12W

Planter Box Only (No Drip Trays or Plants)	Width	Holds Plants	Code	Price
	900W	3	PLBS09	\$160
	1200W	4	PLBS12	\$180
Planter Box with Artificial Plants (No Drip Trays)	900W	3	PLBS09AP	\$429
	1200W	4	PLBS12AP	\$519
Planter Box for Real Plants* (with Drip Trays)	900W	3	PLBS09DT	\$175
	1200W	4	PLBS12DT	\$200

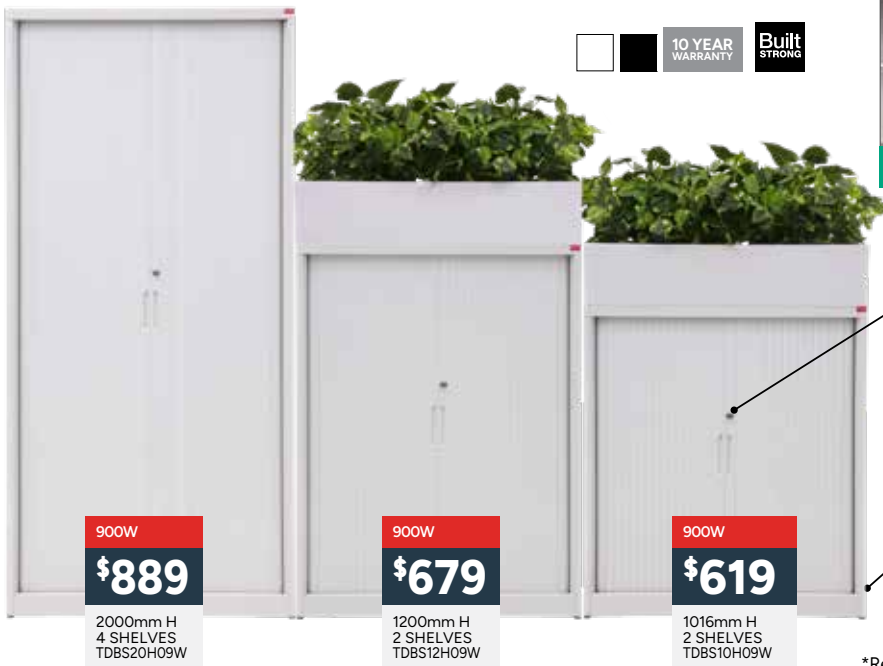

900W
\$889
2000mm H
4 SHELVES
TDBS20H09W

900W
\$679
1200mm H
2 SHELVES
TDBS12H09W

900W
\$619
1016mm H
2 SHELVES
TDBS10H09W

10 YEAR WARRANTY **Built STRONG**



TOAST RACKS
1 For 900W Box / Wrap FSTRxx09 \$55
2 For 1200W Box / Wrap FSTRxx12 \$65

NEW SIZES SPECIFIC TO BUILT STRONG TAMBOURS



Double hook locking system



Levelling feet – adjustable from inside

PLANTER BOX

- 200mm high
- Available in 900W (holds 3 x 200mm dia pots) or 1200W (holds 4 x 200mm dia pots)
- Black or White

*Real plants are not supplied by Empire

9 Huge locations throughout QLD & NSW or BUY ONLINE at empirefurniture.com.au

WOOLLOONGABBA61 Ipswich Rd Woolloongabba.....	4102 P 3132 0605.....gabba@empirefurniture.com.au
SYDNEY36 Parramatta Rd (cnr Mons St) Lidcombe.....	2141 P 9000 1564.....sydney@empirefurniture.com.au
ROCKLEA (FACTORY OUTLET)Gate 1, 51-63 Heaton Street, Rocklea.....	4106 P 3179 6122.....rocklea@empirefurniture.com.au
VIRGINIA1928 Sandgate Rd Virginia.....	4014 P 3477 9692.....virginia@empirefurniture.com.au
<small>(Virginia store relocating to Woolloongabba)</small>				
SOUTHPORT180 Scarborough St Southport.....	4215 P 5625 7560.....southport@empirefurniture.com.au
SUNSHINE COASTShop E, 224 Nicklin Way Warana.....	4575 P 5300 2663.....sunshine@empirefurniture.com.au
ROCKHAMPTON211 East St Rockhampton.....	4700 P 4800 3003.....rockhampton@empirefurniture.com.au
MACKAY2B Victoria St Mackay.....	4740 P 4800 4085.....mackay@empirefurniture.com.au
TOWNSVILLE233 Ingham Rd Garbutt.....	4814 P 4800 4373.....townsville@empirefurniture.com.au

All prices include GST. † Prices do not include delivery, assembly, installation or rubbish removal (unless specified). \$POA We assemble at your request. Conditions apply. *Based on Recommended Retail Price. Prices valid until 31/01/25. Subject to change without notice. Some products and prices may still be available after this date. Late shoppers please enquire. E&OE. Colours reproduced are subject to the usual tolerances of the printing process. Every care has been taken to prevent printing errors. If errors have occurred we will advise you when ordering of the correct price and/or product. Savings are based on our regular retail pricing or similar products available elsewhere. Fabrics, finishes and accessories are used for photography purposes only. We will beat any written quote on equivalent product.



SCAN HERE FOR SHOWROOM DETAILS

