

BACK TO SCHOOL

1000s OF STOCKED ITEMS READY FOR QUICK DELIVERY!

View our full Education Catalogue
96 Pages



VIEW MORE CATALOGUES ONLINE
empirefurniture.com.au/catalogues



SCAN TO VIEW

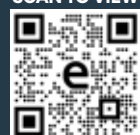

RECENT FITOUTS

Lasso Taper Table
FROM \$197
See page 5 for full details

Lasso Shield Table
FROM \$172
See page 5 for full details

EDCO Chair
FROM \$109
See page 3 for full details

EDCO Stool
ONLY \$149
See page 3 for full details

1800 571 988
empirefurniture.com.au

NO TOTE

FROM

\$159

GRDKC0604

GROW DESKS



- Curved cross-rail provides more leg room on 450mm deep model
- Optional - Tote/rail

See page 4 for full details

Assembly Included



1200 x 600
No Tote
\$224 GRDKC1206

- Tested and Certified to the Australian Standard
- Height adjustable - 9 positions
- Height range 550 - 750mm



7 YEAR WARRANTY



FROM \$45
PLCH335

PLATO CHAIRS



Stacks 10 high

460mm High
\$59 PLCH460/L

New Lower Prices

See page 2 for full details

One piece injection moulded for easy maintenance

Excellent lumbar support to reduce backache

Waterfall front edge designed to reduce pressure behind the knees

Scalloped leg for secure stacking



Lightweight, high-impact, easy-clean, one-piece polypropylene

Angled back legs discourage rocking

No sharp edges

MANY Colours available POA



10 YEAR WARRANTY

- | | | | | | | | | | | | | |
|------------------------------|---------------------------------|------------------------|---------------------------------------|----------------------------------|---|-----------------------------------|------------|------------------------------------|-----------------------------|-------------------------|------------------------------------|----------------------|
| 2 - 5 Student Chairs & Desks | 6 - 12 Student Tables & Benches | 13 STEM & STEAM Tables | 14 - 16 Classroom, Book & Bag Storage | 17 - 18 Teaching Aids & Trolleys | 19 - 20 Whiteboards & Classroom Furniture | 21 Acoustics & Indigenous Fabrics | 22 Lockers | 23 Outdoor, Manual Aids & Sick Bay | 24 - 25 Education Resources | 26 - 27 Stools & Chairs | 28 - 31 Lounges, Booths & Ottomans | 32 - 36 Soft Seating |
|------------------------------|---------------------------------|------------------------|---------------------------------------|----------------------------------|---|-----------------------------------|------------|------------------------------------|-----------------------------|-------------------------|------------------------------------|----------------------|



Queensland Government
One of the Preferred Suppliers for Office, Education and Health Furniture
Whole of Government SOA – QED 104526
Contact us for Approved Products List. www.empirefurniture.com.au/soa



New South Wales Government
Empire Office Furniture is an approved supplier for the NSW Government, under the Office and Education Furniture Contract No. 771. Empire is one of the "Tier 1" suppliers approved to fulfil orders up to and above \$150,000. Empire is approved to supply furniture from 12 product categories, across all NSW regions.

it's easier with
empire
education furniture

EST 1982

Plato Student Chair



Grade	Seat Height (mm)	Code	Suits Desk Height (mm)	Price
Prep-1	335	PLCH335	550-600	\$45
Prep-3	355	PLCH355	600-650	\$49
4-6	400	PLCH400	625-725	\$59
6-12	460	PLCH460/L	725-750	\$59
6-12	460	PLCH460LU (WITH SEAT PAD)	725-750	*\$89

• Also available in smaller heights 240/260/280/300mm *While stocks last

The Plato is versatile

- Lightweight, high-impact, easy-clean, one-piece polypropylene design resists twisting and distortion
- No screws or joins ensures greater strength and durability
- Secure stacking 10 high – compatible stacking with many other brands

Ergonomic design offers exceptional comfort

- A broad back rest and sloped front section provides excellent lumbar support and comfort in all working positions
- Waterfall front edge to reduce pressure behind the knees
- Ventilation aperture facilitates movement of air
- Back leg angle discourages backward rocking

Tested to AS/NZS 4610.2 Education Chairs
180kg Static Load Test
200,000 Seat/Back Fatigue Test



Lightweight, high-impact, easy-clean, one-piece polypropylene

One piece injection moulded for easy maintenance

Excellent lumbar support to reduce backache

New Lower Prices

Waterfall front edge designed to reduce pressure behind the knees

No sharp edges

Scalloped leg for secure stacking

Stacks 10 high

Angled back legs discourage rocking

PLATO LINK (PLCH460L)



The ever popular Plato chair (460mm) is now also available with easy linking feature ideal for school halls, assembly areas, canteens etc.

- This model also has the option of an upholstered seat pad (PLCH460LU)
- Also available chair trolley for easy move and reset (TROLLEY01) **\$489**



10 YEAR WARRANTY

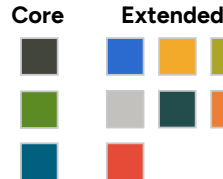

ADVANCED FURNITURE TESTING

The New Benchmark in Certification

Who is Advanced Furniture Testing?

Advanced Furniture Testing is an accredited independent laboratory which tests education furniture to specific Australian and international furniture standards.

Advanced Furniture Testing is accredited by the National Association of Testing Authorities (NATA). It is the most technologically advanced furniture testing laboratory in the Southern Hemisphere.

Empire has Australia's largest selection of tested & certified education furniture.

EDCO Chairs - Flexible ways to Learn!

EDCO CANTILEVER CHAIR AND STOOL

Modern ergonomically designed cantilever chairs absorb the bounce of active children, so teachers don't have to. The robust seat surface is easy to clean and resists scratches. The C-frame makes raising the chairs on desks and tables quick and safe. Glides provide stability and protect floors from abrasion.

A convenient grip hole in the seatback makes carrying this lightweight chair effortless.



**New
Lower
Prices**

380H CHAIR
\$109
EDCHC380

8 Colour
Options

7 YEAR
WARRANTY



660H STOOL
\$149
SAVE \$45
EDSTL660



Supporting ribs

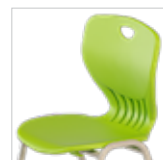

Ergonomic Design



Strong & easy fixing system



Glides provide stability and protect floors from abrasion



Sturdy light metal frame



Strong steel cantilever frame



Glides provide stability and protect floors from abrasion



Replaceable glide elements

Shell Colours



Metal Frame Colours



White Grey Black Charcoal

	GRADE	SEAT HEIGHT	CODE	SUITS DESK HEIGHT (mm)	PRICE	SAVE
EDCO CANTILEVER CHAIR	3-5	380mm	EDCHC380**	625-700	\$109	-
	4-6	430mm	EDCHC430*	675-725	\$115	\$24
	6-12	460mm	EDCHC460*	725-750	\$119	\$26
EDCO 4 LEG STOOL	6-12	660mm	EDSTL660	900	\$149	\$30

*Stocked range: Any colour shell on Black Frame

**Stocked range: Charcoal or Yale Blue shell on Black frame #Indent item - lead times apply

GROW CERTIFIED DESK - 9 HEIGHT POSITIONS

Height adjustable Suits all ages from Prep to Grade 12!

The height adjustable Grow desk caters for the needs of all students from primary school through to high school. Grow desks are tech height adjustable to 9 heights.

- All new design
- Tested and Certified to the Australian Standard



Grow desks feature an 18mm environmentally friendly E-Zero top with tamper-proof, moulded PP edging and a strong steel frame.



"Basketball Impact" Stability Test - 55kg (AS/NZS 4610.3:1999)



NO TOTE
600 X 450
\$159
GRDKC0604

- Curved cross-rail provides more leg room on 450mm deep model
- Optional - Tote/rail

TOP	SIZE (mm)	CODE	PRICE NO TOTE	PRICE WITH TOTE
Single	600W x 450D	GRDKC0604	\$159	\$179
Single	600W x 600D	GRDKC0606	\$179	\$199
Double	1200W x 600D	GRDKC1206	\$224	\$299



NO TOTE
600 X 600
\$179
GRDKC0606

- 600 x 600mm



NO TOTE
1200 X 600
\$224
GRDKC1206

Optional Grow Tote suits Grow 1200w desk

Assembly Included



7 YEAR WARRANTY



Grow leg "height indicator" ensures simple height adjustment

- Height adjustable 9 positions
- Height range 550 - 750mm

Optimal Height Guide*

Children's stature varies greatly within each classroom. For this reason Empire offer 9 x GROW desk heights and 5 x PLATO chair heights. This enables you the best opportunity to select the ideal furniture for your students.

Grade Kindy
Chair Height 300mm
Desk Height 550mm

Grade Prep - 1
Chair Height 335mm
Desk Height 600mm

Grade Prep - 3
Chair Height 355mm
Desk Height 650mm

Grade 4 - 6
Chair Height 400mm
Desk Height 700mm

Grade 6 - 12
Chair Height 460mm
Desk Height 750mm

*Important - this is a guide only, based on the Australian Standard. Empire cannot be accountable for incorrect product selections.

Lasso Desks

PH: 1800 571 988
empirefurniture.com.au

Ask about approved products
SOA QED
104526

CHAIRS CAN
BE STORED
ON DESKS



**30% OFF SELECTED COLOURS
WHILE STOCKS LAST**

LASSO TAPER

RADIUS CORNERS FOR
ADDED SAFETY

OPTIONAL CASTORS FOR
EASY MANOEUVRABILITY

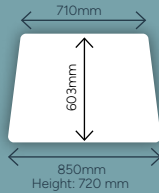

ONLY
\$197
LASTAPER/W



OPTIONAL
TOTE (T) \$23

30% off
Juicy tops
\$136
Save \$61
while stocks last



Lasso Taper Layout Options

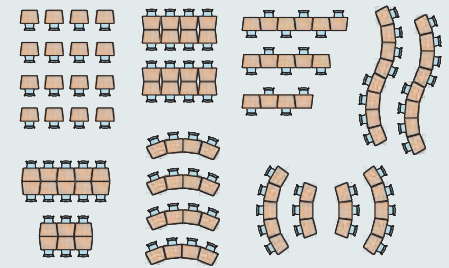

Standard Top colours:



Extended Top Colours:



Frame colours:



LASSO SHIELD



ONLY
\$172
LASSHIELD/W



7 YEAR
WARRANTY

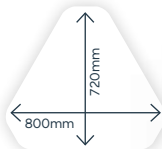

30% off
Juicy tops
\$122
Save \$50
while stocks last

Lasso Shield Layout Options

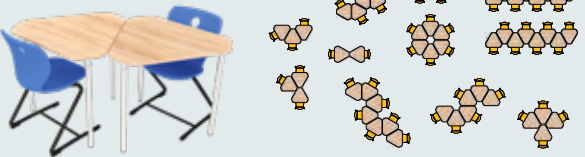

STYLE	LEGS	STATIC	MOBILE	PRICE
SHIELD	3	LASSHIELD	LASSHIELDW	\$172
TAPER	4	LASTAPER	LASTAPERW	\$197
TAPER + TOTE	4	LASTAPERT	LASTAPERWT	\$220

* Prices based on standard Melamine colours **Erasable surface tops add \$10

See page 34



Acer Table Range

Many table settings are not adaptable to changing demands and educators are forced to work around their furniture's limitations.

It was this design flaw which inspired the innovation of our Acer Table Range. Facilitating vast permutations of table configurations in both individual and group-use contexts, our Acer Tables are perfect to liven up and improve the functionality of your space. The range includes fixed, mobile, height-adjustable and flipping frame systems, and modular top shapes that can evolve to include multiple users on demand.

The strength and flexible nature of our frame systems have enabled us to produce highly unique tables, to the extent that if you have a custom table shape in mind, we are confident our frame systems can bring your idea to life!

Check out the quality of our Acer Tables!

They're flexible and strong, perfect for sustained use in any interior environment!



Push-Pin Height Adjustable

With high-strength 1.6mm gauge steel and a high tensile push-pin system, our legs allow 5 different table height options, without sacrificing product stability or integrity. The Acer leg has a 60mm diameter (far superior to similar products at 40mm) ensuring no movement or rattle.



Mobile Lockable Wheels

Standard with mobile, height adjustable and flipping frames, our mobile castors make reconfiguration a breeze - once you've found the perfect spot, simply lock the castors and you're set!



Optional Glides

Glides can be interchanged with castors. All height adjustable tables are available with four glides or as a combination of two glides and two castors.



Top Quality Laminates and ABS Edging

Our table tops come standard with quality laminate finishes and high-impact ABS edging, to ensure that your top withstands your day-to-day activities, with little sign of wear.

ACER LEG AVAILABLE IN SILVER OR BLACK RIPPLE

Core Colours



Extended Colours

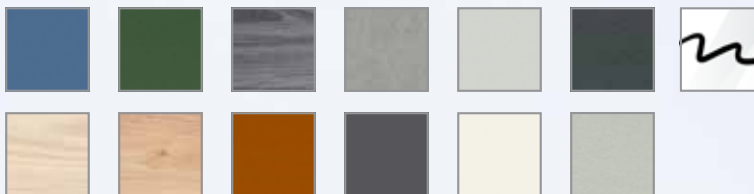

Tested to AS/NZS 4610.3
Education Tables

**No Rattle,
Guaranteed**

**7 YEAR
WARRANTY**



UP TO 25% OFF • SELECTED COLOURS AND SHAPES • WHILE STOCKS LAST

Available Table Frames: (Check specific products to see which frames apply)



Fixed Height Leg
(with levelling feet)
720 mm high



Fixed Height Leg
(with lockable castors)
720 mm high

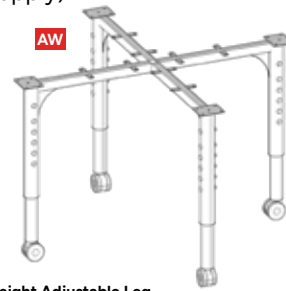

Height Adjustable Leg
(with lockable castors)
6 heights: 550 | 610 | 640 | 680 | 720 | 750 mm

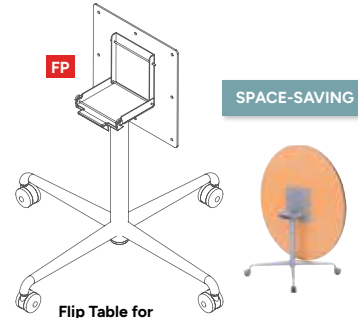

Flip Table for Easy Storage
(with lockable castors)
720 mm high

SPACE-SAVING

Available Bench Frames: (Check specific products to see which frames apply)

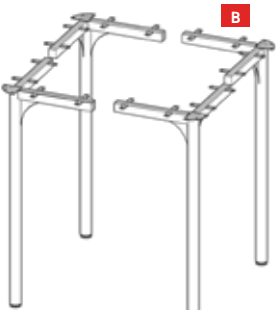

Fixed Height Leg
(with levelling feet)
900 mm high

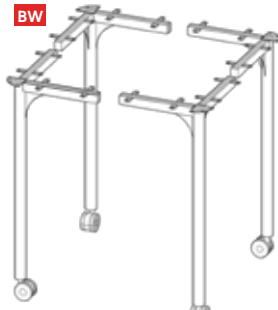

Fixed Height Leg
(with lockable castors)
970 mm high

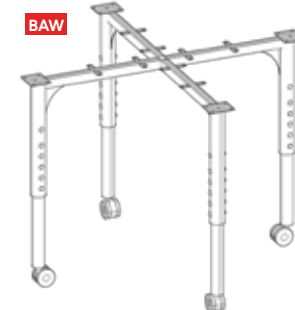

Height Adjustable Leg
(with lockable castors)
6 heights: 720 | 780 | 810 | 850 | 900 | 930 mm



Optional Bell Glides (ACBELLGLIDE)
Height adjustable tables are also available with 4 glides or in combination of 2 glides and 2 castors

COMPARE OUR TOP SIZES

Acer tables offer lower "cost per student"... Acer 1200 mm diameter tables accommodate four students, other 900 mm diameter tables accommodate one student.

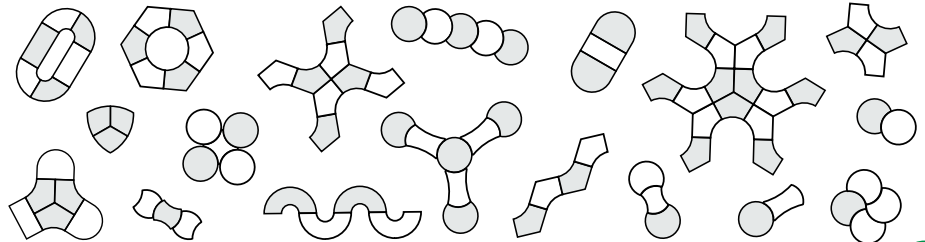

ACER IDEAL FOR EDUCATIONAL USE

All Acer tops are 18mm thick MDF Optional Bell Glides (ACBELLGLIDE)

Core Top Colours:



Top Shape	Fixed Height with Levelling Feet		Fixed Height with Castors		Height Adjustable with Castors		Bench Height with Levelling Feet		Bench Height with Castors		New Adjustable Bench Height with Castors		Flip Frame	
	Code	Price	Code	Price	Code	Price	Code	Price	Code	Price	Code	Price	Code	Price
1a Round	ACTROUND	\$287	ACTROUNDW	\$315	ACTROUNDW	\$315	ACTROUNDW	\$315	ACTROUNDW	\$315	ACTROUNDW	\$315	ACTROUNDW	\$315
1b Round Whiteboard	ACTROUND.WB	\$317	ACTROUNDW.WB	\$345	ACTROUNDW.WB	\$345	ACTROUNDW.WB	\$345	ACTROUNDW.WB	\$345	ACTROUNDW.WB	\$345	ACTROUNDW.WB	\$345
2a Pentagon 60°	ACTPENTA60	\$379	ACTPENTA60W	\$414	ACTPENTA60W	\$414	ACTPENTA60W	\$414	ACTPENTA60W	\$414	ACTPENTA60W	\$414	ACTPENTA60W	\$414
3 Fan	ACTFAN	\$307	ACTFANW	\$335	ACTFANW	\$335	ACTFANW	\$335	ACTFANW	\$335	ACTFANW	\$335	ACTFANW	\$335
4 Bone	ACTBONE	\$287	ACTBONEW	\$315	ACTBONEW	\$315	ACTBONEW	\$315	ACTBONEW	\$315	ACTBONEW	\$315	ACTBONEW	\$315
5 Trinity	ACTTRI	\$297	ACTTRIW	\$325	ACTTRIW	\$325	ACTTRIW	\$325	ACTTRIW	\$325	ACTTRIW	\$325	ACTTRIW	\$325
6 Star	ACTSTAR	\$297	ACTSTARW	\$325	ACTSTARW	\$325	ACTSTARW	\$325	ACTSTARW	\$325	ACTSTARW	\$325	ACTSTARW	\$325
7a Crescent	ACTCRESC	\$297	ACTCRESCW	\$325	ACTCRESCW	\$325	ACTCRESCW	\$325	ACTCRESCW	\$325	ACTCRESCW	\$325	ACTCRESCW	\$325
7b Crescent WB	ACTCRESC.WB	\$327	ACTCRESCW.WB	\$355	ACTCRESCW.WB	\$355	ACTCRESCW.WB	\$355	ACTCRESCW.WB	\$355	ACTCRESCW.WB	\$355	ACTCRESCW.WB	\$355
8a Arc	ACTARC	\$352	ACTARCW	\$380	ACTARCW	\$380	ACTARCW	\$380	ACTARCW	\$380	ACTARCW	\$380	ACTARCW	\$380
8b Arc Whiteboard	ACTARC.WB	\$392	ACTARCW.WB	\$420	ACTARCW.WB	\$420	ACTARCW.WB	\$420	ACTARCW.WB	\$420	ACTARCW.WB	\$420	ACTARCW.WB	\$420
9a D-End	ACTDEND	\$342	ACTDENDW	\$370	ACTDENDW	\$370	ACTDENDW	\$370	ACTDENDW	\$370	ACTDENDW	\$370	ACTDENDW	\$370
9b D-End Whiteboard	ACTDEND.WB	\$372	ACTDENDW.WB	\$400	ACTDENDW.WB	\$400	ACTDENDW.WB	\$400	ACTDENDW.WB	\$400	ACTDENDW.WB	\$400	ACTDENDW.WB	\$400
10 Quarter	ACTQUART	\$379	ACTQUARTW	\$414	ACTQUARTW	\$414	ACTQUARTW	\$414	ACTQUARTW	\$414	ACTQUARTW	\$414	ACTQUARTW	\$414
11a Rectangle	ACT1575	\$332	ACT1575W	\$360	ACT1575W	\$360	ACT1575W	\$360	ACT1575W	\$360	ACT1575W	\$360	ACT1575W	\$360
11b Rectangle Whiteboard	ACT1575.WB	\$362	ACT1575W.WB	\$390	ACT1575W.WB	\$390	ACT1575W.WB	\$390	ACT1575W.WB	\$390	ACT1575W.WB	\$390	ACT1575W.WB	\$390
12 Helix	ACTHELIX	\$307	ACTHELIXW	\$335	ACTHELIXW	\$335	ACTHELIXW	\$335	ACTHELIXW	\$335	ACTHELIXW	\$335	ACTHELIXW	\$335
13 Axis	ACTAXIS	\$401	ACTAXISW	\$443	ACTAXISW	\$443	ACTAXISW	\$443	ACTAXISW	\$443	ACTAXISW	\$443	ACTAXISW	\$443

"Erasable Surface" tops \$POA

FURTHER SAVINGS AVAILABLE
SCAN TO VIEW

EDUCATION RUN-OUT SPECIALS

Acer Table Range

1

ROUND



Fixed Height
\$287 ACTROUND

Height Adjustable (Mobile)
\$395 ACTROUNDAW



7

CRESCENT



Fixed Height
\$297 ACTRESS

Height Adjustable (Mobile)
\$405 ACTRESSAW



9

D-END

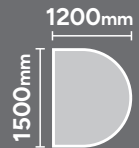

Fixed Height
\$342 ACTDEND

Height Adjustable (Mobile)
\$450 ACTDENDAW



2

PENTAGON

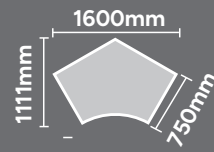

	i (mm)	ii (mm)
A 60°	1600	1111

Fixed Height

\$379 ACTPENTA60

Height Adjustable (Mobile)

\$514 ACTPENTA60AW

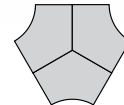

A

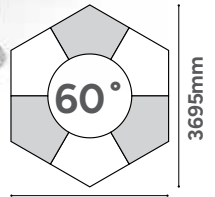

NEW

A

3200mm

11

RECTANGLE

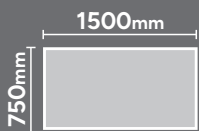

Fixed Height
\$332 ACT1575

Height Adjustable (Mobile)
\$440 ACT1575AW



8

ARC

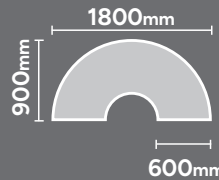

Fixed Height
\$352 ACTARC

Height Adjustable (Mobile)
\$460 ACTARCAW



"Erasable Surface" tops \$POA

SCAN TO VIEW

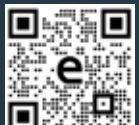

MORE RECENT FITOUTS

5

TRINITY

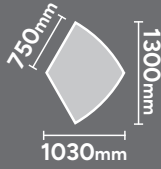

Fixed Height
\$297 ACTTRI

Height Adjustable (Mobile)
\$405 ACTTRIAW



4

BONE

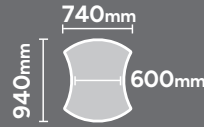

Fixed Height
\$287 ACTBONE

Height Adjustable (Mobile)
\$395 ACTBONEAW



10

QUARTER

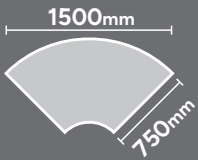

Fixed Height
\$379 ACTQUART

Height Adjustable (Mobile)
\$514 ACTQUARTAW



12

HELIX

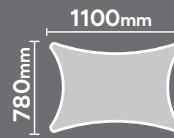

Fixed Height
\$307 ACTHELIX

Height Adjustable (Mobile)
\$415 ACTHELIXAW



3

FAN

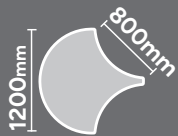

Fixed Height
\$307 ACTFAN

Height Adjustable (Mobile)
\$415 ACTFANAW



6

STAR

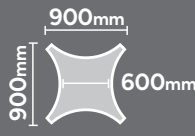

Fixed Height
\$297 ACTSTAR

Height Adjustable (Mobile)
\$405 ACTSTARAW



13

AXIS

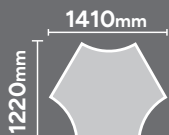

Fixed Height
\$401 ACTAXIS

Height Adjustable (Mobile)
\$563 ACTAXISAW



SCAN TO VIEW



EDUCATION
RUN-OUT SPECIALS



ADVANCED
TESTED &
CERTIFIED



7 YEAR
WARRANTY

Tested to AS/NZS 4610.3
Education Tables

"NO RATTLE, GUARANTEED!"

QUADRIC TABLES FIXED HEIGHT

• 25mm steel frame

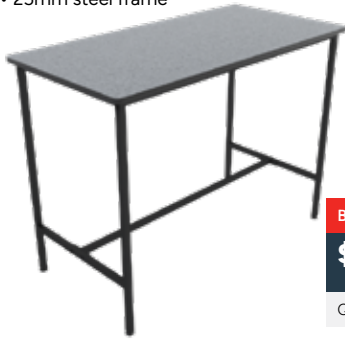

BENCH
\$242
QDBE1206



FROM
\$155
QDTB0606W



New
Fully Welded
Design



QUADRIC TABLES HEIGHT ADJUSTABLE

• 30mm steel frame



ONLY
\$202
QDTB0606WT



ONLY
\$272
QDTB1206WT

HEIGHT
ADJUSTABLE

- H565-765
- 5 convenient height adjustments in one easy to adjust leg

Core Colour:



Extended Colours

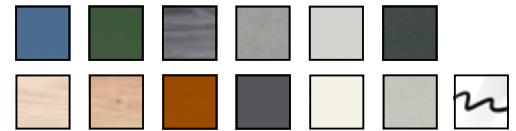

7 YEAR WARRANTY



MANY Colours available POA

SIZE	TABLES 720mm FIXED HEIGHT	PRICE	HEIGHT ADJUSTABLE 565-765mm H	PRICE
600W x 600D	QDTB0606W	\$155	QDTB0606WT	\$202
700W x 550D	QDTB0705W	\$155	QDTB0705WT	\$205
1200W X 600D	QDTB1206W	\$217	QDTB1206WT	\$272
BENCHES - 900mm FIXED HEIGHT				
1200W X 600D	QDBE1206	\$242		

QUADRIC FOLD-UP EXAM TABLE

730 HIGH
\$139
QDFTB0805



- Durable 18mm MDF Silver top with radiused corners for safety and durable high impact edging resists knocks and scratching.
- H730 x W800 x D550mm
- Folding frame

Optional
Quadric fold up exam table trolley **\$1140**
QDFTBTR16

Assembly Included



LEXIE FOLDING EXAM TABLE

FROM
\$139
LEXFTB7505.GY



NEW

- 725H x 750W x 500D
- Lightweight and durable
- Foldable legs for easy storage
- Solid steel frame
- Tough ABS top with built in pencil tray

10 YEAR WARRANTY

SPECIAL DISCOUNT FOR ORDER QUANTITIES OF 100 OR MORE
LEXFTB7505100.GY



Optional
Lexie Trolley
\$849
LEXFTBTR18

Fits up to 18 Lexie Folding Exam Tables

STAX EXAM TABLE

FROM
\$99
STAXTABLEB



Optional
Stax Trolley
\$200
Save **\$137**
STAXTROLLEY

- H720 x W750 x D700mm
- 12mm MDF Top (E1) with heavy duty slimline rod frame
- Available in Diamonds top with Pearl Silver powdercoat frame or Oak top with black frame
- Stackable up to 25 high on a trolley



3 YEAR WARRANTY



ALBERT EXAM TABLE



- Lightweight, stacking polypropylene table ideal for exam time.
- W740 x D500 x H720

ONLY
\$129
ALBTB0705

ACER STUDY CARREL



- W900 x D600
- 720mm High (desk height)
- 1220mm overall height
- Private study carrel
- Ideal for libraries



ONLY
\$343
ACTCARREL

7 YEAR WARRANTY

PONDER CARREL



*4 x Ponder Carrel Seating not included

- The modular design of the Ponder Carrel makes them ideal for grouping together.
- W835 x D600 x H1200

ONLY
\$279
PDPONDER

4 Leg Tables



TIMMY STEEL-FRAME TABLES & BENCHES

Choose the size that suits your needs! Best prices!



ALSO AVAILABLE
"Tested and Certified"
model Emmy steel frame
table EMSFXXXX \$POA

BENCHES

Quick Ship Colours



- Priced in Select Beech, Red Cherry, Natural Oak or White Tops
- Many sizes & colours available \$POA
- 40mm sturdy steel tube with 25mm Top
- Adjustable feet

SIZES	A 4 LEG (BLACK) (735mm H)	B BENCHES (1025mm H)	C FOLDING (SILVER) (735mm H)
900 X 600	\$224 TISF0960.XX	\$264 TISFH0960.XX	-
1200 X 600	\$259 TISF1260.XX	\$299 TISFH1260.XX	-
1500 X 750	\$294 TISF1575.XX	\$364 TISFH1575.XX	\$329 SHFT1575.XX
1800 X 750	\$319 TISF1875.XX	\$389 TISFH1875.XX	\$349 SHFT1875.XX
1800 X 900	\$359 TISF1890.XX	-	\$379 SHFT1890.XX

FOLDING TABLES



TIMMY TABLES - 19 colours & many sizes available \$POA				
1. 600 x 600	6. 1200 x 600	11. 1500 x 750	16. 1800 x 900	
2. 600 x 750	7. 1200 x 750	12. 1500 x 900	17. 1800 x 1200	
3. 900 x 600	8. 1200 x 900	13. 1500 x 1200	18. 2100 x 600	
4. 900 x 750	9. 1200 x 1200	14. 1800 x 600	19. 2100 x 750	
5. 900 x 900	10. 1500 x 600	15. 1800 x 750	20. 2100 x 900	
Lengths: 600/900/1200/1500/1800/2100mm			21. 2100 x 1200	
Widths: 600/750/900/1200mm		Heights: 735/1025mm		

EXAMINER TRAPEZOID TABLE



- 1265W x 550D
- Diagonal width - 630mm
- Height options - 560, 625, 685, 725mm
- 18mm melamine top
- Powder coat steel frame

ECHO FLIP TABLE

NEW Black frame available!

3 Frame Colours

Top Size	Code	Price
1500L x 750D x 725H mm	ECH1575	\$459
1800L x 750D x 725H mm	ECH1875	\$479
1500L x 750D x 650H mm	ECH1575L	\$459
1500L x 750D x 650H mm	ECH1875L	\$479

• Adjustable length beam
• 650mm high version - ideal for primary school

ACER FLIP TABLE

3 YEAR WARRANTY

FROM \$569

1200mm Dia. ACFPROUND

Erasable surface tops now available 1200mm Dia. Only \$599 ACFPROUNDWB

5 YEAR WARRANTY

Citi & AXIOM BENCHES

- Range of sizes
- Lengths: (CT) 1200, 1500, 1800mm (AX) 2400, 3000, 3600mm
- Depths: (CT) 600, 750, 900 (AX) 1200mm
- Heights: 1050mm or 900mm
- Double frames available for long benches (AXBL)

SAVE 10%

New Lower Prices

MANY Colours available POA



Citi 50/50 Bench	Static (Adj Feet)				Mobile (Lockable Castors)		
	Top size	Code	Price	Save	Code	Price	Save
	1200 X 600	CT5BEx1260	\$476	\$53	CT5BExM1260	\$494	\$55
	1500 X 750	CT5BEx1575	\$525	\$59	CT5BExM1575	\$543	\$61
	1800 X 750	CT5BEx1875	\$557	\$62	CT5BExM1875	\$575	\$64
	1800 X 900	CT5BEx1890	\$611	\$68	CT5BExM1890	\$629	\$70

x = H (1050mm high) or L (900mm high)



MOBILE BENCH



Island Tables bring people together whilst setting them apart

Ideal for meetings, collaboration and individual work in libraries, staff rooms, breakout spaces and administration. Available in 3 heights (720mm, 900mm, 1050mm) that can be mixed and matched to keep things interesting.



See pg. 34



ISLAND LINEA TABLE

PRODUCT	CODE	SIZE (mm)	PRICE
Island Linea Table	ISLTB2412	W2400 x D1200 x H720	\$739
Rondo Ottomans	PDROND05	W470 x D470 x H425	\$199



ISLAND LINEA LOW BENCH

PRODUCT	CODE	SIZE (mm)	PRICE
Island Linea Low Bench	ISLBEL2412	W2400 x D1200 x H900	\$899

*Chairs not included



ISLAND CURVE TABLE

PRODUCT	CODE	SIZE (mm)	PRICE
Island Curve Table	ISLTB1212	W1200 x D1200 x H720	\$449
Rondo Ottomans	PDROND05	W470 x D470 x H425	\$199
Nova Lounge	NOVA02L	W1200 x D680 x H745	\$839
Pebble Table	PEBB400	W400 x D400 x H650	\$219



CURVE TABLE & CURVE LOW BENCH COMBO



ISLAND CURVE LOW BENCH

PRODUCT	CODE	SIZE (mm)	PRICE
Island Curve Low Bench	ISLBEL1212	W1200 x D1200 x H900	\$509

*Chairs not included

PLANTA



PRODUCT	CODE	SIZE (mm)	PRICE
Planta 1200	PLLOW1200	W1200 x D300 x H450	\$289
Planta 1200	PLHIGH1200	W1200 x D300 x H800	\$389
Planta 1370	PLLOW1370	W1370 x D300 x H450	\$329
Planta 1370	PLHIGH1370	W1370 x D300 x H800	\$499
Planta 1500	PLLOW1500	W1500 x D300 x H450	\$369
Planta 1500	PLHIGH1500	W1500 x D300 x H800	\$549

*Plants not provided.
Live plants require self-watering system - not provided.



PANGEA + MARUCHI

PRODUCT	CODE	SIZE (mm)	PRICE (EACH)
2 x Island Curve Table	ISLTB1212	W1200 x D1200 x H720	\$449
Planta 1200	PLHIGH1200	W1200 x D300 x H800	\$389
Maruchi Stool	MARST490	D330 x H490	\$99

*Plants not included

STEM | STEAM | MAKER SPACES



FROM
\$642
SRTA1812

Also available without sides

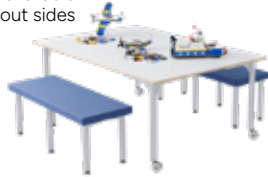

TOTES INC.
\$1355
SRBE1812T15
+TOTEX20

Also available without sides



STEAMROLLER MAKER ACCESS

- The Steamroller Maker Table is available in two heights and is ideal for coding, robotics or any activity that needs room to explore.
- Stools not included
- SRTA1812 W1800 x D1200 x H720 **\$642**
- SRBE1812 W1800 x D1200 x H900 **\$670**

STEAMROLLER MAKER ENGAGE

- The Steamroller Maker Engage Table allows students to get up close whilst keeping resources and supplies conveniently at hand.
- Prices include 15 totes (sold separately, see pg. 16)
- W1800 x D1200 x H900



Double Sided
TOTES INC.
\$1609
SRBEEEXP1812
+TOTEX20

Also available without sides



TOTES INC.
\$1789
SRBEACT1812
+TOTEX20

Also available without sides

STEAMROLLER MAKER EXPLORER

- The Steamroller Maker Explorer Table with its 20 pull out totes can accommodate resources for the entire class as they explore.
- Prices include 20 totes (sold separately, see pg. 16)
- W1800 x D1200 x H900

STEAMROLLER MAKER ACTION

- The Steamroller Maker Action Table offers generous storage for resources right in the centre of the action, ready to explore!
- Prices include 30 totes (sold separately, see pg. 16)
- Stools not included
- W1800 x D1200 x H900

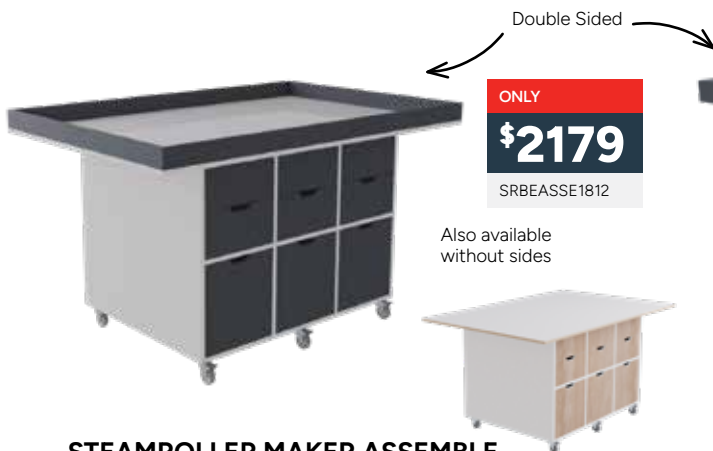

Double Sided
ONLY
\$2179
SRBEASSE1812

Also available without sides



ONLY
\$1359
SRBEPLAN1812

Also available without sides

STEAMROLLER MAKER ASSEMBLE

- The Steamroller Maker Assemble Table with its numerous storage drawers will have you exploring, learning and interacting.
- Drawers included
- W1800 x D1200 x H900

STEAMROLLER MAKER PLANNER

SRBEPLAN1812

- The Steamroller Maker Planner Table provides generous cupboard storage right at the table for robotics and other resources.
- Cupboard & Doors included
- Stools not included
- W1800 x D1200 x H900



See pg. 34

Customise your Storewell Storage with optional totes, drawers & doors

STOREWELL 8 BAY



• The ultimate in storage, the Storewell 8 Bay unit can hold it all with its configurable doors, drawers and tote boxes.

FROM
\$629
STSTOREH08

STOREWELL 8 BAY + TOTES



AS PICTURED
\$829
STSTOREH08
+TOTEX20

STOREWELL 8 BAY + MIXED TOTES



AS PICTURED
\$989
STSTOREH08
+TOTEX20

STOREWELL 8 BAY + DRAWERS



AS PICTURED
\$1069
STSTOREH08
+DRAWERS

STOREWELL 8 BAY + DOORS



AS PICTURED
\$749
STSTOREH08
+DOORS

STOREWELL 6 BAY



- The Storewell open bay unit can easily be customised to meet all your storage needs with the range of accessories.
- W1200 x D450 x H854

FROM
\$519
STSTOREH06

STOREWELL 6 BAY + DRAWERS + TOTES



AS PICTURED
\$744
STSTOREH06
+DOORS
+TOTEX20

MANY Colours available POA

See pg. 34

STOREWELL 4 BAY



- The ever practical Storewell 4 bay is a flexible solution for your storage needs. Ideal for offices and classrooms.
- W870x D450 x H854

FROM
\$369
STSTOREH04

STOREWELL 4 BAY + DRAWERS



AS PICTURED
\$629
STSTOREH04
+DRAWERS



ACCESSORIES

*See tote colours on pg. 16



TOTES				DOORS			DRAWERS		
DESCRIPTION	LENGTH mm	CODE	FROM PRICE	DESCRIPTION	LENGTH mm	FROM PRICE	DESCRIPTION	LENGTH mm	FROM PRICE
Mini Tote+Rails	365W x 420D x 115H	TOTE120	\$25	Single Door	375W x 18D x 375H	\$30	2 x Small Drawers	375W x 420D x 187H	\$65
2 x Mini Tote/ Maxi Tote+Rails	365W x 420D x 270H	TOTE220	\$45	-	-	-	Large Drawer	375W x 420D x 375H	\$45

Book Storage

Ask about approved products
SOA QED
104526



TOTES INC.
\$1539
FUSSTOREWEMB
+TOTEX20

FUSION WEMBLEY

- Fusion Wembley sits atop a storage frame to create a browser and organisation centre.
- W1200 x D900 x H1172
- Prices include totes (sold separately, see pg. 16)

Double Sided



FROM
\$399
INFBBBC09

INFORM BOOKCASE

- The Inform Bookcase is accessible from both sides. Perfect for books and other resources.
- INFBBBC09 W900 x D600 x H950 **\$399**
- INFBBBC12 W900 x D600 x H1250 **\$489**
- INFBBBC15 W900 x D600 x H1550 **\$599**
- INFBBBC18 W900 x D600 x H1850 **\$749**



ONLY
\$555
FUSBOOKBR

FUSION BROWSER

- The Fusion Book Browser sits atop a lightweight frame and is ideal for book browsing in school libraries.
- W1200 x D900 x H750

MANY
Colours
available
POA
See page 34



KUBE MAXI
\$519
KUBEMAX



RUBIX MAXI
\$909
RUBIXMAX



ONLY
\$1009
RUBIXTOW

RUBIX TOWER

- The Rubix Book Tower is ideal for highlighting popular book series for quick access all sides making book selection easy.
- Four sided storage
- W804 x D804 x H1690



ONLY
\$739
BOOKDISSPIN

BOOK SPINNER

- This spinner features 5 tiers, is free standing and rotates. Holds approximately 180 paperbacks or 250 series books.
- W580 x D580 x H1610



KUBE MIDI
\$409
KUBEMID

- The Kube Browser is ideal for highlighting popular book collections or series in an easy to select book display unit.
- Two sided storage
- **Kube Maxi** W804 x D804 x H1074
- **Kube Midi** W804 x D804 x H681



RUBIX MIDI
\$989
RUBIXMID

- The Rubix Browser is ideal for fiction series books with accessibility all sides for easy access and selection.
- Four sided storage
- **Rubix Maxi** W1200 x D1200 x H1311
- **Kube Midi** W1200 x D1200 x H1088

BAG STORAGE



STOREWELL 4 BAG STORAGE UNIT

- Accommodating a school bag and tote for each student, the Storewell Bag + Tote unit is a classroom staple.
- W810 x D500 x H1075
- Prices include single totes (sold separately, see pg. 16)

TOTES INC.
\$479
STSTOREBAG04
+TOTEX20

MANY
Colours
available
POA
See page 34

Taller height fits standard sized school bags + tote



STOREWELL 8 BAG STORAGE UNIT

- This classroom staple accommodates a school bag and tote for each student to keep student belongings together.
- W1600 x D500 x H1075
- Prices include single totes (sold separately, see pg. 16)

TOTES INC.
\$799
STSTOREBAG08
+TOTEX20

CUBO SEAT & STORAGE

Customise your Cubo Storage with optional Storewell totes, drawers & doors

CUBO SINGLE SEAT

FROM
\$209

CUBOSEAT01



- W414 x D450 x H511

CUBO 3 SEAT

FROM
\$439

CUBOSEAT03



- W1200 x D450 x H511

CUBO 2 SEAT



- W807 x D450 x H511
CUBOSEAT02 From **\$309**

CUBO 4 SEAT



- W1593 x D450 x H511
CUBOSEAT04 From **\$529**

CUBO 8 SEAT

FROM
\$909

CUBOSEAT08



- Double Sided
• W1593 x D900 x H511

MANY Colours available POA

See page 34

ACCESSORIES

*See tote colours below



TOTES				DOORS			DRAWERS		
DESCRIPTION	LENGTH mm	CODE	FROM PRICE	DESCRIPTION	LENGTH mm	FROM PRICE	DESCRIPTION	LENGTH mm	FROM PRICE
Mini Tote+Rails	365W x 420D x 115H	TOTE120	\$25	Single Door	375W x 18D x 375H	\$30	2 x Small Drawers	375W x 420D x 187H	\$65
2 x Mini Tote/ Maxi Tote+Rails	365W x 420D x 270H	TOTE220	\$45	-	-	-	Large Drawers	375W x 420D x 375H	\$45

TOTE STORAGE

STOREWELL 5 TOTE

TOTES INC.
\$324

STSTORETOTE05 +TOTE20



- Overall size: 414cm(W) x 450cm(D) x 904cm(H)
- Prices include totes (sold separately, refer Storewell Totes below)

STOREWELL 10 TOTE

TOTES INC.
\$499

STSTORETOTE10 +TOTE20



- Overall size: 807cm(W) x 450cm(D) x 904cm(H)
- Prices include totes (sold separately, refer Storewell Totes below)

STOREWELL 15 TOTE

TOTES INC.
\$709

STSTORETOTE15 +TOTE20



- Overall size: 1200cm(W) x 450cm(D) x 904cm(H)
- Prices include totes (sold separately, refer Storewell Totes below)

STOREWELL TOTE TRAYS (WORKS WITH CUBO, STEAMROLLER, TOWER, STOREWELL TROLLEYS, BOOK & BAG STORAGE)

White

TOTE120.WH



Classic Totes
420W x 365D x 120H
\$20

Charcoal

TOTE120.CH



Maxi Totes
420W x 365D x 220H
\$40

Orange

TOTE120.OR



TOTE220.WH

TOTE220.CH (Stocked)

TOTE220.OR

TOTE220.GNLT

TOTE220.CRA

TOTE220.PU

Light Green

TOTE120.GNLT



Cranberry

TOTE120.BUR



Purple

TOTE120.PU



TC TOTE TROLLEYS



TC SINGLE TOTE TROLLEY

TOTES INC.

\$329

TCXTOTTR1 +TCXTOTTRAY

- 5 trays
- H920 x W380 x D440mm
- Prices include totes (sold separately, see pg.25)



TC DOUBLE TOTE TROLLEY

TOTES INC.

\$489

TCXTOTTR2 +TCXTOTTRAY

- 10 trays
- H920 x W740 x D440mm
- Prices include totes (sold separately, see pg.25)



TC TRIPLE TOTE TROLLEY

TOTES INC.

\$689

TCXTOTTR3 +TCXTOTTRAY

- 15 trays
- H920 x W1100 x D440mm
- Prices include totes (sold separately, see pg.25)

SATELLITE TEACHERS LECTERN



FROM
\$589
SATLECTERN

SATELLITE TEACHERS CADDY



FROM
\$649
SATCADDY

SATELLITE TEACHERS PODIUM



FROM
\$659
SATPODIUM

SATELLITE TEACHERS CADDY WITH SHAPED TOP



FROM
\$739
SATCADDYT

• Top size: W750 x D600

• Top size: W900 x D550

- Standard Features**
- Base size: W485 x D500 x H1070
 - With side out worktray
 - Heavy duty locking castors
 - Gang lock (all locking drawers)



STERLING



4 drawer + slimline handles
\$689 SATE04HLT



2 drawer + cupboard scalloped handles
\$659 SATE03SLT



4 drawer with top & scalloped drawer handles
\$909 SATE04TSLT



Open with top
\$569 SATE02TSLT

TEACHERS TOWER

1800 H TOTES INC.
\$959
TEACHTOW18 +TOTEx20



Side 1



Side 2

1200 H TOTES INC.
\$719
TEACHTOW12 +TOTEx20



- 1000W x 600D
- Double sided
- Mobile whiteboard and storage unit
- Prices include totes (sold separately, see pg. 16)

NEW-MATIC GAS LIFT LECTERN



GAS LIFT!

ONLY
\$529

NMTA650

- New design with easy lift capacity
- Table top section is 650 x 400mm
- Height adjustable from 750–1120mm
- Powder coated satin white steel stand with 40mm lockable castors

BREAKROOM TABLE

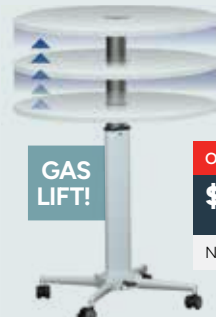

GAS LIFT!

ONLY
\$549

NMMT800

- Unique patented pneumatic air lift mechanism
- Table top 800mm in 18mm white E1 melamine
- Height adjustable 688–1058mm
- 40mm lockable castors with powder coated ivory steel stand

UPTOWN GAS HEIGHT ADJUSTABLE TABLE/ LECTERN



GAS LIFT!



NEW

ONLY
\$299
UPTB0605

- Lift capacity
- Total load capacity 40kg
- Table top section is 600 x 550mm
- Height adjustable from 750–1150mm
- Tablet groove
- Drink holder
- Lockable castors

DESK BUGGY GAS HEIGHT ADJUST

- Strong one-piece castor base
- Sit to stand adjustability
- Large twin-wheel castors (2 lockable)
- Sealed gas cylinder
- Device storage slot, suitable for tablet or phone
- Contoured top with round edge to prevent chipping
- Easy one hand gas lift operation

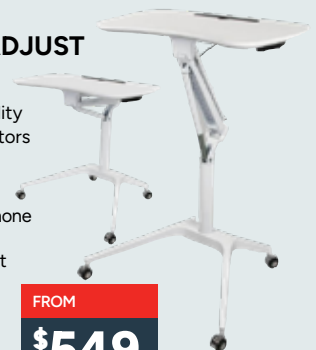

FROM
\$549

DKBUG01.WH

10 YEAR WARRANTY

NEW

EXAMINER TROLLEY RANGE

TV/VIDEO

ONLY
\$749

EXTRTV

- Black frame
- H1220 x W850 x D600mm
- 18mm E-Zero melamine shelves
- Heavy duty castors

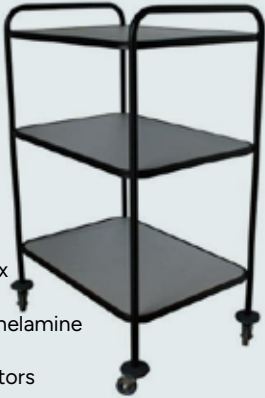

MOBILE ART

ONLY
\$979

EXTRART

- Powdercoated steel frame
- H975 x W720 x D485mm
- 4 shelves
- Includes 6 totes
- Heavy duty lockable castors



GENERAL PURPOSE

ONLY
\$929

EXTR3T

- Three powdercoated shelves
- H840 x W590 x D540mm
- Heavy duty lockable castors with corner buffers



BOOK

ONLY
\$829

EXTRLIB

- Locally manufactured
- H950 x W810 x D475mm
- Available in a range of colours
- 3 tiers
- 2 double-sided shelves
- Heavy duty castors



LABORATORY

ONLY
\$889

EXTRLAB

- Two powdercoated shelves
- H820 x W810 x D470mm
- Heavy duty lockable castors with corner buffers



MOBILE TRAY STORAGE

ONLY
\$999

EXTRTOTE12

- Powdercoated tubular steel frame
- H870 x W820 x D575mm
- Heavy duty castors
- Holds 12 SF120 tote trays (not included)
- Tote size H90 x W530 x D450mm



THE "BIG A" PORCELAIN MOBILE WHITEBOARD

ONLY
\$1389

TRBIGAMW1809

NEW

- 1800H x 900W
- Large magnetic double-sided porcelain scratch resistant writing surface
- Satin silver aluminium frame finish
- Minimal assembly required
- Fold flat and store when not in use
- Large internal storage tray



FUSION LEARNING CENTRE

ONLY
\$659

FUSIONSTD

- Strong paper holder
- Heavy duty locking castors
- Includes rear storage
- Includes magnetic whiteboard
- 830W x 450D x 1560H
- * Tote boxes extra \$20ea TOTE120



CEO LECTERN

ONLY
\$289

CEOL01

3 YEAR WARRANTY

- Extra Shelf
- LED Lamp (Batteries Inc)
- Locking Castors



XO MOBILE RESOURCE CENTRE

SMALL
\$339

XORES01

- Steel handle
- H1000 x W598 x D450mm
- Lockable single drawer and door



BUSTLE MOBILE WHITEBOARD

ONLY
\$2219

TRBUSMW12

- 1850H x 1110W (Board Size: 1180H x 1110W)
- Includes removable magnetic pen shelf (480W)
- Hex key included
- Dark charcoal aluminium legs
- 4x Foldable legs with gliding castors
- Powder coat orange aluminium board frame



MOBILE WHITEBOARDS

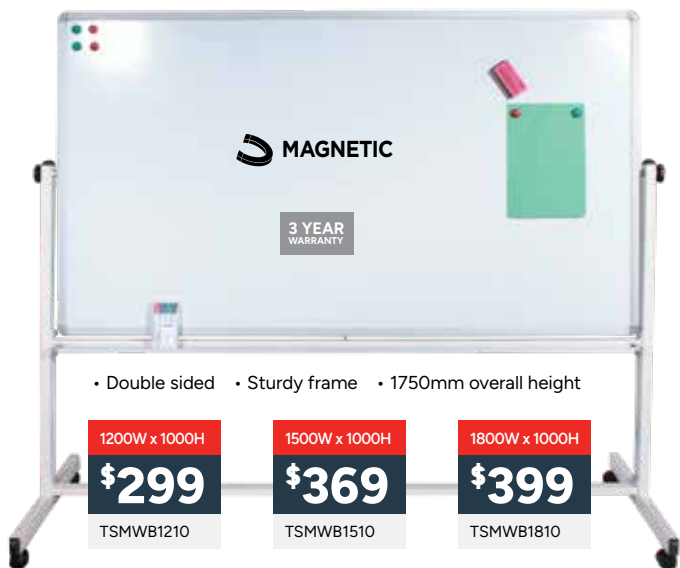

MAGNETIC

3 YEAR WARRANTY

- Double sided
- Sturdy frame
- 1750mm overall height

1200W x 1000H \$299 TSMWB1210	1500W x 1000H \$369 TSMWB1510	1800W x 1000H \$399 TSMWB1810
--	--	--

BLOK SCREENS

FROM
\$289
SAVE \$45
BLOK1515



- 50mm thick
- Pinnable surface

Size	Price	Code
1500H x 1500W	\$289	BLOK1515
1500H x 1800W	\$319	BLOK1518
1800H x 1500W	\$319	BLOK1815
1800H x 1800W	\$349	BLOK1818



NOW AVAILABLE IN BLACK BACKED SURFACE

1200W x 600H	\$409	TRMG1206B
1800W x 1200H	\$989	TRMG1812B
900W x 600H	\$219	TRRLGB0906
1200W x 900H	\$469	TRRLGB1209
1500W x 900H	\$579	TRRLGB1509
1500W x 1200H	\$679	TRRLGB1512
1800W x 900H	\$659	TRRLGB1809
1800W x 1200H	\$759	TRRLGB1812
2100W x 1200H	\$859	TRRLGB2112
2400W x 1200H	\$979	TRRLGB2412

MAGNETIC DESIGNER GLASS BOARD

- Lifetime stain free surface
- 4mm safety toughened glass
- 8 times stronger than glass
- 500mm glass pen shelf
- 5 super magnets supplied

FROM
\$249
TRMG0906

CITI FREE STANDING PANEL SCREEN

1200H		
750W	\$324	CTFS1275.CH
1200W	\$384	CTFS1212.CH
1500W	\$424	CTFS1215.CH
1800W	\$474	CTFS1218.CH
1500H		
750W	\$334	CTFS1575.CH
1200W	\$434	CTFS1512.CH
1500W	\$494	CTFS1515.CH
1800W	\$554	CTFS1518.CH

- Silver Fabric/Black Frame
- Black Fabric/White Frame

ONLY
\$324
CTFS1275.CH



COMMUNICATE ROOM DIVIDER



3 YEAR WARRANTY

ONLY
\$749
COMD02

- 900W x 1800H
- Side 1 - magnetic whiteboard with magnetic pen shelf and adjustable flipchart pad hooks
- Side 2 - pinnable charcoal fabric
- Each Divider can be linked together with the Connector Kit **\$29** COMD01
- 90mm locking castors

FELT PINBOARDS

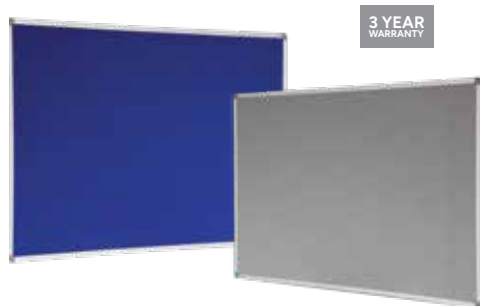

3 YEAR WARRANTY

- Strong extra thick felt
- Wall fixings supplied
- Available in Blue or Grey

Size	Price	Code
900W x 600H	\$69	TSPB0906
1200W x 900H	\$119	TSPB1209
1500W x 900H	\$159	TSPB1509
1800W x 900H	\$169	TSPB1809
2400W x 1200H	\$299	TSPB2412

WALL MOUNT WHITEBOARD



MAGNETIC

- No pen residue
- Solid aluminium frame
- Concealed wall fixings

3 YEAR WARRANTY

25 YEAR WARRANTY

Commercial Grade			Porcelain Surface	
Size	Price	Code	Price	Code
900W x 600H	\$79	TSWB0906	\$119	TRRLPWW0906
1200W x 900H	\$129	TSWB1209	\$209	TRRLPWW1209
1500W x 900H	\$169	TSWB1509	\$309	TRRLPWW1509
1800W x 900H	\$199	TSWB1809	\$359	TRRLPWW1809
1800W x 1200H	\$249	TSWB1812	\$389	TRRLPWW1812
2400W x 1200H	\$299	TSWB2412	\$509	TRRLPWW2412
3000W x 1200H	\$369	TSWB3012	\$649	TRRLPWW3012

STERLING RANGE

The Sterling range is a comprehensive selection of heavy duty furniture designed specifically for the rigours of the classroom.

Many matching items available.

Features

- Australian Made
- E-Zero
- Many other laminate colours available.
- All Adjustable shelves are 25mm – extra thick and strong

BEST BUY deals on admin furniture
View our Office Furniture brochure



SCAN HERE TO VIEW THE CATALOGUES



We manufacture to your design

CHOOSE YOUR COMBINATION FROM 68 COLOURS

Extra Strong Shelving



900mm Wide Bookcases (no doors)*				900mm Swing-Door Cupboards			
Description	Code	Dimensions (mm)	Price*	Description	Code	Dimensions (mm)	Price
Single side	A STBC0930/C	H900 x D315	\$339	Static	H STSC12	H1200 x D600	\$785
	B STBC0945/C	H900 x D450	\$424	Mobile	I STSC12C	H1200 x D600	\$845
	C STBC0960/C	H900 x D600	\$507	Static	J STSC18	H1800 x D600	\$1,060
	D STBC1245/C	H1200 x D450	\$532	Static	K STSC21	H2100 x D600	\$1,218
	E STBC1260/C	H1200 x D600	\$649	4 Door Credenza			
Double side	F STBCD0960/C	H900 x D600	\$507	Description	Code	Dimensions (mm)	Price
	G STBCD1260/C	H1200 x D600	\$641	Mobile	L STSC1545C	H725 x W1500 x D450	\$785

Teacher's Desk			
Description	Code	Dimensions (mm)	Price
Desk (no drawers)	M STDK1575	H725 x W1500 x D750	\$368
Desk (locking drawers)	N STDK1575D	H725 x W1500 x D750	\$638
1 Dr/File Mobile Pedestal	O STMP1DF	H590 x W470 x D530	\$376
Mobile Desk Extension	P STDKEX900	H760 x W910 x D600	\$643

Priced without castors. Optional castors /C add \$60

All Sterling drawers are lockable

MOBILE
\$643
STTRBOOKC



STERLING BOOK STORAGE



STATIC
\$1010
STBDISP/C

Mobile Book Trolley
• H680 x W1225 x D650mm

Book Display
• H1225 x W1225 x D650mm
• Optional castors add \$90

NOISE REDUCING ACOUSTIC WALL PANELLING



Uniting contemporary First Nations design and acoustic functionality, the Autex Acoustics® x Willie Weston collection has been curated for education, government and commercial spaces.

Locally manufactured on Cube™ and Quietspace® Panel, the range is comprised of eight designs in 21 colourways and is entirely carbon neutral.

The specification of each design contributes to fair and equitable income for each artist via Willie Weston, a profit-for-purpose business working in partnership with First Nations artists to support the integration of contemporary First Nations design into the built environment.

Features:

- Carbon neutral
 - Available in 6mm, 12mm, 24mm, and 25mm thicknesses
 - Available in 2400mm, 2700mm, and 3000mm lengths
- PLEASE CONTACT US FOR A CUSTOM QUOTE**

THE COLLECTION



- NRC 0.45 - 0.85
- Group 1 fire rating
- Safe, water-based, UV cured ink
- Locally manufactured in Australia

INDIGENOUS MATERIALISED FABRICS

YINDI

Supporting Indigenous Designers and Manufacturing

Enquire about customising your furniture with indigenous prints.

Many designs and colourways to choose from



materialised

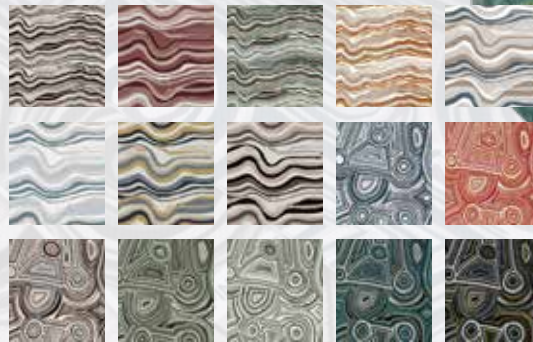

Designs by Jimmy Pike, Robyn Caughlan and more

PEEL & STICK ACOUSTIC WALL TILES

Transform your walls into acoustic notice-boards

- 35 Colours to choose from
- Eco-Friendly
- Velco-Compatible and Pinnable
- These tiles are "Permanent Stick" (Non-Permanent also available \$POA APSAxx)
- Pack of 6 Tiles (covers 2.16 sq.m)
- Each Tile is 600mm x 600mm (12mm)

PACK OF 6

\$299

AUPSWT0606Q6



NOISE-REDUCING "ACOUSTICO" PANELS

Redefine your school environment with premium acoustic solutions from Empire.

- Effectively Controls reverberated noise
- Suitable for Walls and Ceilings
- Eco-Friendly

- Group 1 Fire Rated
- Unlimited design choices
- Ceiling Tiles APCTxx
- Wall mounted pinboard/panels (semi-permanent) APSAxx
- 6mm cut to shape, custom wall decorations APSHAPExx

EDU PLASTIC SCHOOL LOCKERS

FSPxx

NEW

FOLLOW 3 EASY STEPS TO ORDER:

- Step 1: Choose depth, width and height
- Step 2: Choose number of doors (1-9)
- Step 3: Choose colour of body and doors (25 colours)

EDU Plastic Lockers (Aus. Pat No. 2011903047) have unique advantages over lockers made from traditional materials such as wood, laminate and metal.

- UV stable with a huge range of anti-fade colours to choose from
- Lightweight & stackable so they are easy to move and install
- The lockers are made of Heavy Duty Polyethylene with a high-grade stainless steel hinge - so they are perfect for wet areas, coastal locations and the outdoors
- Quieter than metal or timber lockers, no banging doors
- Graffiti is easier to remove - no painting required
- Easy to clean and lowest maintenance, just hose them out!
- Proven strength and durability - backed by a 15 year warranty
- Options: Sloping top, kick base, number plates, hanging rails/hooks & USB cable



PHONE LOCKERS FSPPHONE

Optional USB wiring kit for Phone Lockers include 4 ports and wires. FSPPHONEKIT

- 4 doors per vertical unit
- 180W x 240D x 600Hmm
- Strong and Durable
- UV Stable



EMPIRE EDUCATION LOCKERS

ASSEMBLY INCLUDED

Optional sloping top:
Great for keeping the tops of your lockers tidy.

Fully Laminated Carcass:
All lockers come standard with sealed, laminated board for optimal hygiene, health and safety.

Many configurations:
1, 2 or 3 bay
1, 2 or 3 door
3 heights: 1830, 1270 or 970mm

Moisture-resistant base:
Each locker carcass is elevated with a 40mm high base plinth to protect from any moisture or dirt from the floor.

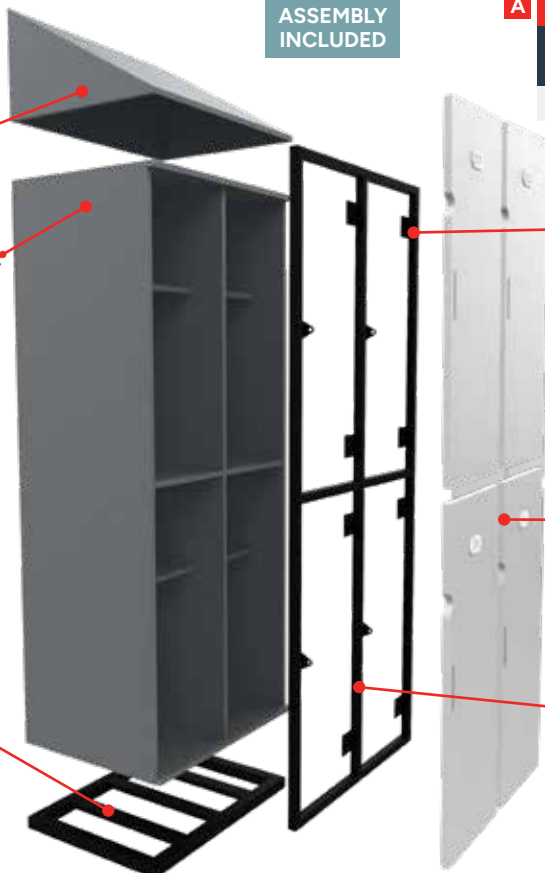

A 6 DOOR
\$1549
LKEDH203

B 4 DOOR
\$429*
SAVE \$460
LKED202

HALF PRICE

Heavy-duty hinges:
Each door is locked to the carcass with heavy-duty hinges and tamper-proof rivets, built to withstand 24/7 use. These hinges also facilitate economical door replacement in the event of vandalism.

Fully ABS edged doors:
Doors are completely sealed for health and safety. *Doors can be routed to include locker numbering as an add-on option.

7-year warranty and reinforced frame:
Steel locker frames are over-engineered to ensure long-term use, and absorb day-to-day knocks.



H1830 x W720 x D580mm

Locker Options (\$POA)



Combination Locks

Charging / Power

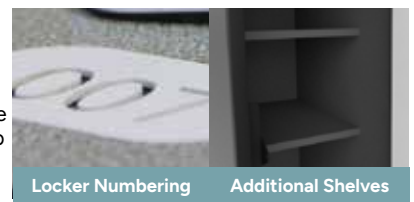

Locker Numbering

Additional Shelves

*While Stocks Last

ALUMINIUM OUTDOOR FURNITURE

CAROL OUTDOOR SETTING

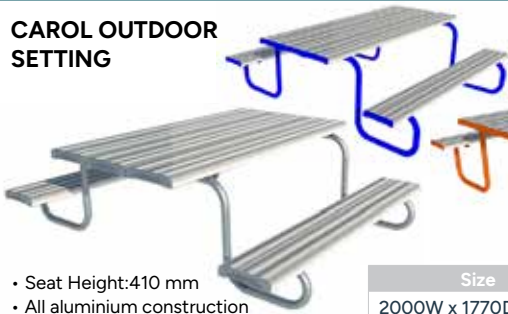

- Seat Height: 410 mm
- All aluminium construction
- Lightweight
- Durable
- Low maintenance



Size	Code	Size	Code
2000W x 1770D x 710H	CAROL2000	2000W x 255D x 400H	HARV2000
2400W x 1770D x 710H	CAROL2400	2400W x 255D x 400H	HARV2000
3000W x 1770D x 710H	CAROL3000	3000W x 255D x 400H	HARV2000
4000W x 1770D x 710H	CAROL4000	4000W x 255D x 400H	HARV2000

HARVEY BOLT-DOWN BENCH SEAT



- All aluminium construction
- Low maintenance
- Lightweight
- Durable

EXAMINER MANUAL ARTS RANGE

OXY WELDING BENCH EXBNWELD

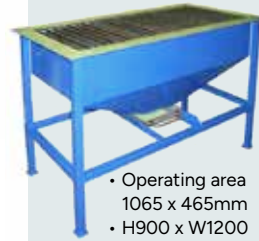

- Operating area 1065 x 465mm
- H900 x W1200 x D535mm

ARC WELDING BENCH EXBNARCWELD



- Heavy duty steel frame
- H900 x W1200 x D600mm

SICK BAY



SICKBAY COUCH (HIGH) BED01

- Fully welded 38mm round Black steel frame
- Ply base and back with Dunlop Enduro Foam
- Adjustable back rest
- 1800W x 600D x 840Hmm



SICKBAY COUCH (LOW) BED02

- Fully welded 38mm round Black steel frame
- Ply base and back with Dunlop Enduro Foam
- Adjustable back rest
- Includes Arms
- 1800W x 600D x 440Hmm

WOODWORK BENCH EXBNWW1200



- Four 175mm woodwork vices
- H810 x W1240 x D1240mm

TAFE WORK BENCH EXBNTAFE



- Hardwood top with iron angle frame
- H825 x W1660 x D850mm

DELUXE TAFE WORK BENCH EXBNTAFEC



- Two vices and lockable storage cupboards
- H825 x W1660 x D850mm

WOODWORK BENCH EXBNWW240



- Two 175mm woodwork vices
- H850 x W2400 x D750mm

SICO CHORAL RISERS & STAGING



UNIT HEIGHT mm
Fixed single height 410
Fixed single height 610
Dual height adjustable 410 or 610
Dual height adjustable 610 or 810



RISER SIZE	UNIT HEIGHT mm
3 Step Riser	1840W x 1410D
4 Step Riser	1980W x 1840D
Side Guardrail Set (2)	Made to fit

SICO CHORAL RISERS SICxx

These innovative risers have a quick reverse-step system that makes it easy to change your riser configuration from the traditional semi-circular arrangement to straight or other interesting combinations - without tools!

- Use this feature to build unique configurations for show-choir, or double-choir concerts.
- Available in Grey carpet

SICO PORTABLE STAGING SICxx

Each section of our mobile 1800 Series Portable Stage is designed to be handled and set up by just one person, creating significant time savings and minimal effort for you.

- Available in 1830W x 2440Lmm modules (Black carpet)
- Many sizes and options available

THERAPY PEANUT BALL

- Builds strength, flexibility and balance with a positive vestibular input
- Ridged surface provides extra grip
- Pthalate and BPA free
- 80cm Long with 40cm diameter ball ends



ONLY
\$55
TCPB

CALMING CANOE

- Provides the right amount of pressure to boost sensory integration skills and develop motor planning
- Particularly appropriate for those with Sensory Processing Disorder (SPD) Requires inflation
- 178cmL x 80cmW x 48cmH



ONLY
\$275
TCCCB

DIP ROCKING CHAIR

- Weight per chair: 23kg
- Each Seat: 390L x 450W x 360Hmm



ONLY
\$69
TCXDRC4

Available in 4 colours

SMALL PLASTIC CADDY

Perfectly sized for little hands - now you can safely and neatly store and display pens, pencils, craft materials etc.

- 123H x 235W x 227Dmm
- 3 Sections (2 Small, 1 Large)
- Available in 10 colours



- | | | | | |
|--------|------------|---------|-------|--------|
| | | | | |
| Red | Lime green | Magenta | Teal | Blue |
| | | | | |
| Purple | Light Blue | Yellow | Green | Orange |

ONLY
\$8
TCXSPSC

ON YOUR MARKS

- Set of 10 in single or assorted coloured packs
- Attaches to short weave carpet
- Velcro hook and loop dot
- Also available in Large size (14cm)
10 Pack **\$21** TCOYML10
30 Pack **\$55** TCOYML30



10CM 10 PACK
\$17
TCOYM10



10CM 30 PACK
\$44
TCOYM30

ANYWHERE CHAIR

The Anywhere Chair is able to recline and fold completely flat, making storage incredibly easy

- 555mm wide
- Available in red, blue, green and orange
- Reclines and folds flat for easy storage



ONLY
\$121
TCSFCX

WRIGGLE CUSHION

- Includes a pump and storage bag.
- Green only
- 380mm diameter



ONLY
\$44
TCWC

CLOUD CHAIR

- Includes Filling
- 100 UV Protected
- Coated Polyester Cover
- Wipe Clean, Water Repellent

Small
62cm x 62cm x 72cm H
Suitable for Pre-school / Lower Primar

Medium
97cm x 91cm x 71cm H
Suitable for Primary

Available in 4 colours

- | | |
|-------|--------|
| | |
| Red | Yellow |
| | |
| Green | Blue |



SMALL
\$237
TXCCCS

MEDIUM
\$264
TXCCCM

Z-FLEX DESK

Versatile work surface for writing or using laptops on the floor, in a chair, or outdoors.

Flexible solution for classrooms and home schooling - students can take notes and work on the go.

- 60L x 37W x 30Hcm
- Made from Polyurethane, Available in Blue, Green & Red



ONLY
\$44
TCXZFLEX

LAP TRAY TABLE

Pack of 4

- H200 x W580 x D300mm
- Sturdy and easy to clean
- Storage compartments
- Stackable
- Choose set of 4 in one colour (Red, Primary Blue or Lime Green), Bright Mix (Purple, Red, Lime Green, Primary Blue) or Pastel Mix (Teal, Magenta, Lime Green, Light Blue)



ONLY

\$44

TCLTT4

PLASTIC BOOK TUB

- H195 x W100 x D265mm (130mm high front)
- 15 colours

Plastic colours



ONLY

\$10

TXCPBT

Frame available - holds 5 book tubs. **\$95** sold separately BTDCS

BOOK READER STORAGE BOX

ONLY

\$22

TCXBRSB5



- Supplied in packs of 5 (single colour or 5 options of "Mix Packs")
- Super-strong laminated card
- H280 x W170 x D250mm (H170mm front)

PLASTIC TOTE TRAY

- H125 x W430 x D320mm
- 10 colours: Purple, Orange, Red, Yellow, Green, Blue, Light Blue, Magenta, Black & White



ONLY

\$20

TCXTOTTRAY

ART DRYING PACK

ONLY

\$499

ARTDR25

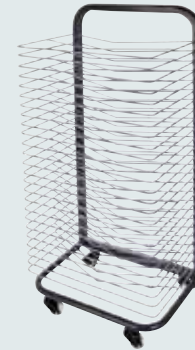

- 25 shelves
- 2 x lockable castors
- 2 x standard castors

COLOUR SQUARE PLACEMENT RUG

- 3 x 2 metres
- 6m² sitting area
- Also available: 12m² (30 squares) **\$779** TCRUGCSLB30

Many designs and sizes

ONLY

\$660

TCRUGCSP



SOLID COLOUR RUGS

Overall size: 3m x 4m for 12m² seating area!

12m²

\$440

TCRUGSG



Available in blue or green

12m²

\$440

TCRUGSB

INDIGENOUS SEASONS RUG

- 2 sizes available: Large - 3m x 2m (6m² sitting area) TCASCL
- Small - 1.5m x 1m (1.5m² sitting area) TCASCS

1.5m²

\$220

TCASCS



6m²

\$924

TCASCL

CAMPFIRE RUG

- 3m x 4m - 12m² sitting area

12m²

\$880

TCRUGCAMP



Stools & Chairs

PEEKABOO STOOL

ONLY
\$75
SAVE \$10
PEEK01

1 YEAR
WARRANTY



12 STACKABLE



STOOL COLOURS



The Peekaboo is perfect for a wide variety of uses. It features a seamless design to add strength and stability, while being lightweight, which means it is easily stacked and easy to move.

- Size: 400W x 410D x 467Hmm

- IF Design Award winner 2020
- Solid and lightweight design
- 12 stackable
- Open backrest for easy handling
- Suitable for both indoor and outdoor use*

PLATO STOOL



2 HEIGHTS
\$119
PLSTXX

Made from polypropylene that is easy to wipe down and clean.

- Heights: 370mm or 450mm
- Diameter 330mm
- Base encourages movement



SIDEKICK SWIVEL STOOL



NO RING
\$119
NOT PICTURED
SIDE01

With drafting ring (as pictured)
\$199 SIDE02

- Seat height 530mm to 740mm
- Seat diameter 400mm
- Black leather-look (PU) seat
- Chrome finish on base and gas spring

TRINA STOOL



GAS LIFT
\$149
TRINA01.xx

- Active Seating wobble stool
- Underseat hand grip
- Solid PP material
- 300mm dia x 400mm H
- 3 Colours – Fuchsia, Mint, Sky Blue

BUTTON ACTIVE SITTING STOOL



ONLY
\$179
BTTN400W/500W

- Seat height: 400 and 500mm
- Diameter 300mm • Convex base design
- Promotes healthy sitting with mobility
- Available in Blue, Green, Orange and Red

BARBELL STOOL



3 YEAR
WARRANTY
ONLY
\$209
BARBELL01

- Gas height adjustable – 100mm Range
- Slip resistant TPE base
- Fabric covered seat



PERCH STOOL

ONLY
\$319
PERCH01

- Gas lift
- Seat height range 595–840mm
- Seat diameter 300mm
- Available in Black or Blue
- Not yet submitted for DET 68449 SOA approval



CATO RANGE "Strength In Steel"



NO BACK
\$99
CATO650



- Seat height: 650mm
- Splayed legs minimise potential for tipping
- Stacks 7 high



WITH BACK
\$109
CATO650B



- Seat height: 650mm
- Art, Graphics and Science stool
- Stacks 7 high

SAFEHOOK

With a recessed design, the Safehook is the perfect option for a safe bag hook unit with not protruding hooks. The Safehook is designed for schools with a high level of wear and tear ideal for heavy traffic.

- 177H x 480W x 45Dmm
- 3 colours - Beige, Black and White
- 4 hooks per unit
- Safe recessed design with no protruding hooks
- Designed for schools
- Flame retardant
- UV Stabilised allowing for internal or external application
- Wall fixing kit and instructions included with each unit

ONLY
\$89
SAFEHOOK

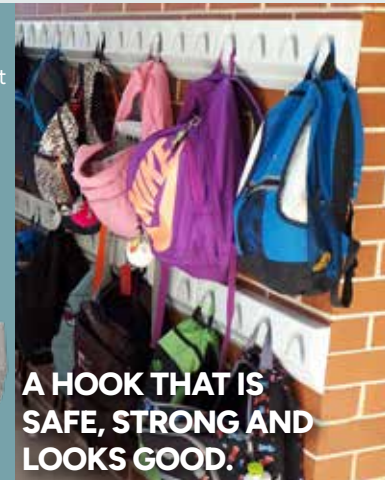

A HOOK THAT IS SAFE, STRONG AND LOOKS GOOD.

SOLIDWORX – AUSTRALIA’S TOUGHEST TRAINING CHAIR



NO ARMS
\$309
SWRX61W.BK



WITH ARMS
\$349
SWRX62W.BK

Foldable arm rest



RIGHT TABLET
\$409
SWRX63W.BK

- Foldable arm rest and tablet
- Tablet on RHS
- Size W330 x D260mm

- Features:**
- Plastic back • Stackable
 - Foldable seat for nesting
 - Iron tube leg and PU castors
 - Simple and effective linking
 - All components meet min of BIFMA standard
 - Greenguard certified



Linking Kit
\$30 SWRXLINK



Stacking Trolley
\$279 SWRX66.BK

PU LAB STOOLS

- Features:**
- High quality moulded PU
 - Hard wearing and easy to clean

A1
Height range:
340-580mm



B2



Height range:
560-820mm

Ref	Style	Code	Price
A1	Saddle	LABST02	\$199
A2	Saddle (with Drafting kit)	LABST02D	\$239
B1	Chair	LABCH23N	\$289
B2	Chair (with Drafting kit)	LABCH33N	\$349

VERVE VISITOR RANGE

VERVE RANGE



PLASTIC STOOL
\$159
NO ARMS
VERS81P

- 5 YEAR WARRANTY**
- Chrome frame
 - 762mm seat height
 - Black plastic seat and back
 - Fully assembled



PLASTIC
\$99
NO ARMS
VERS61P

- 10 YEAR WARRANTY**
- Tested to AS/NZS 4688
 - Fixed Height Chairs



FABRIC
\$159
NO ARMS
VERS61F

- LINKING CAPABILITY**
- 10 YEAR WARRANTY**
- 160kg Static Load Test
 - 100,000 Seat/Back Fatigue Test

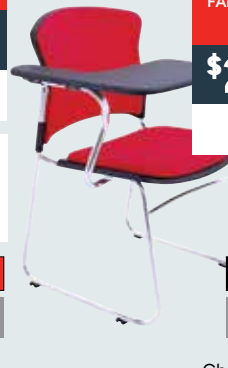

FABRIC WITH TABLET
\$219
NO ARMS
VERS63F

- Choice of left or right tablet
VERS63xL.xx
VERS63xR.xx



PLASTIC WITH TABLET
\$159
NO ARMS
VERS63P

- 10 YEAR WARRANTY**
- VERVE TROLLEY**
\$100
VERS66
- Holds 10 x Fabric or 20 x Plastic



The Mixx Range

Australia's most versatile range of high quality break out visitor seating

NOW AVAILABLE IN 5 "ON TREND" COLOURS



17 VIBRANT COLOURS TO CHOOSE FROM



Plastic shell only

BASE STYLE	CODE	DETAIL (ALL PRICES PLASTIC SHELL)	PRICE
A 4 LEG	MIX61xx	Metal frames options	\$159
B SLED	MIX71xx	Chrome/Black/Woodgrain	\$159
C 4 LEG TIMBER	MIX61Tx		\$149
D STOOL (630 or 760H)	MIX630x/760x	Black or Chrome frame	\$209
E TIMBER LEG STOOL	MIX630Tx/760Tx	Black or Chrome foot ring	\$239
F 5 STAR BASE	MIX13x	Black nylon, gas lift and castors	\$219
G UPHOLSTERED SEAT	Optional Upgrade	Warwick gravity fabric	ADD \$90
H FULLY UPHOLSTERED	Optional Upgrade	Warwick gravity fabric	ADD \$250
I ARMS	Optional Upgrade	Lt.Grey/Black/White	ADD \$40

Also available with an upholstered seat (F), fully upholstered (G) or with arms (H)

RAINBOW SOFT-SEATING SYSTEM

MODULAR
& MOBILE

Square Back

Shaped Back



- Smart design - 4 simple pieces
- Solid ply construction
- Heavy duty locking castors
- Easily reconfigured
- Priced in Category 1 fabric
- 100s of fabric options **\$POA**
- Seat height 450mm
- Back height 750mm

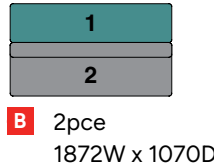
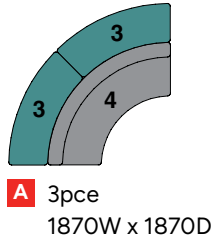

BACK STYLE	SHAPE	CODE	PRICE
NO BACK	1 - Straight	RAIN1SNB	\$879
	3 - Curve	RAIN3CNB	\$829
SQUARE BACK	2 - Straight	RAIN2SWB	\$1269
	4 - Curve	RAIN4CWB	\$1489
SHAPED BACK	2 - Straight	RAIN5SSB	\$1489
	4 - Curve	RAIN6SSB	\$1699



FONZETTA MOBILE BENCH SEAT

FROM
\$1379
FONZ02



Shown in Mandarin Rave fabric

- Dimensions: 1100H x 1520W x 600Dmm
- Seat height: 450mm
- Priced with E-Zero, Zincworks melamine carcass, upholstered in Ashcroft fabric or Lustrell vinyl
- Other fabrics available (**\$POA**)
- 6 lockable castors

**Assembly
Included**



LION LOUNGE CHAIR

FROM
\$659
LION01



MANY
Colours
available
POA

- 850H x 570W x 850Dmm
- Priced in Rave fabric or Lustrell vinyl
- Other fabrics available (**\$POA**)

EASY CHAIR

FROM
\$259
EASY01



MANY
Colours
available
POA

See page 34

- W590 x D720mm
- Seat height: 410mm
- Black frame and fabric

PEBBLE SIDE TABLE

ONLY
\$219
PEBB400



- 400/350W x 400D x 650H
- Solid Steel Design with Heavy Base for Stability
- Available in Black or White

SUNRISE MODULAR LOUNGE SYSTEM

- Many layout configurations available
- Stocked in new commercial grade fabric (Charcoal)
- Booth panels upholstered in designer quilted fabric



Flax Fabric Colours



Quilted Fabric Colours



1 SEAT/NO ARMS
\$519
SRISE01L



BOOTHS FROM
\$819
SAVE 50%
SRISE01LB

*While stocks last



Seat	No Arms - 750H x 750D			With Arms - 750H x 750D			Bench - 420H x 750D			Booth - 1400H x 750D			
	Length mm	Code	Price	Length mm	Code	Price	Length mm	Code	Price	Length mm	Code	Without USB	With USB
1	650	SRISE01L	\$519	890	SRISE01LA	\$839	650	SRISE01B	\$369	710	SRISE01LB	\$819*	\$839*
2	1300	SRISE02L	\$1109	1540	SRISE02LA	\$1429	1300	SRISE02B	\$809	1360	SRISE02LB	\$1329*	\$1369*
3	1950	SRISE03L	\$1499	2190	SRISE03LA	\$1819	1950	SRISE03B	\$1049	2010	SRISE03LB	\$1729*	\$1799*



Low-line
Coffee Table
640W x 640D x
270Hmm
\$129 SRISE0606

(\$POA)

Prices for Stocked Charcoal Fabric only. Extended Colour Range POA *Special prices on Booth Lounge Charcoal fabric seat and Storm fabric screens *While stocks last

ORIGAMI SINGLE BOOTH

1 SEAT BOOTH
\$1249
ORIGBTH01



VE Fabric Colours



- The acoustic absorption of the Origami Sofa Booth reduces external noise making it ideal for private study.
- W850 x D800 x SH450

ORIGAMI TWO SEAT BOOTH



2 SEAT BOOTH
\$1899
ORIGBTH02

- The acoustic absorption of the Origami Sofa Double Booth reduces external noise making it ideal for private gatherings.
- W1600 x D800 x SH450

An endless array of seating for informal learning and breakout areas

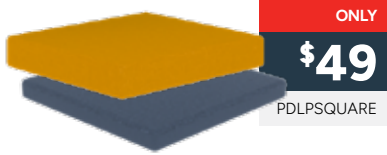

ONLY
\$49
PDLPSQUARE

LILYPAD SQUARE
PDLPSQUARE

- The Lilypad Square seat pad can be housed in Cubo or Rubix storage units.
- W375 x D375 x H50



ONLY
\$59
PDLPPET

LILYPAD PETAL CUSHION
PDLPPET

- The Lilypad Leaf is the perfect place to stop and enjoy a story or group activity.
- D480 x H50
- PDLPPETTROLLEY
Lilypad Petal Trolley



ONLY
\$249
ELETRIOT

ELEMENTS® TRIANGLE OTTOMAN

- Cute and comfy, our angular Elements Triangles are small in size, big in appeal.
- W680 x D590 x H450



ONLY
\$69
PDLPCENT

LILYPAD ROUND

- Our Lilypad Round Cushions are made for storytime.
- PDLPCENT **Lilypad Leaf** D600 x H50
- PDLPTROLLEY **Round Trolley** \$179 D690 x H1200

MANY Colours available POA
See page 34



ONLY
\$199
PDFLOWPET

PETAL OTTOMAN

- The beautiful petal ottoman with its soft, curved shape fans around tables.
- D460 x H425



ONLY
\$199
PDROND05

RONDO

- Light enough to pull up and join the group, Rondo is ideal for occasional seating.
- D470 x H425



ONLY
\$189
PDCUBE

CUBEE

- Convenient to slide where needed, Cubee provides fun casual seating on the go.
- W420 x D420 x H425



FROM
\$249
PDCIRC06

CIRCO

- The Circo Ottoman is available in 3 sizes to create fun circular seating pods anywhere.
- PDCIRC06 D600 x H425 **\$249**
- PDCIRC09 D900 x H425 **\$429**
- PDCIRC12 D1200 x H425 **\$699**



ONLY
\$1449
PDBAGEL

BAGEL

- Flexible, comfortable and versatile, Bagel is the modular ottoman for small spaces.
- D1400 x H425



ONLY
\$1254
PDFLOWER

FLOWER

- This collection of 6 ottomans will help work bloom. Mix and match colours available.
- D1300 x H425



ONLY
\$1822
PDSUNFLOWER

SUNFLOWER

- The 8 piece Sunflower is a well loved addition to any large breakout space. Mix and Match.
- D1620 x H425



Pictured x 2

HABITAT D END OTTOMAN

- The Habitat D End sits neatly at the end of lounges to create a soft curve or circle.
- W1050 x D525x H450

ONLY
\$399
HABDEND

MANY Colours available POA
See page 34



ELEMENTS® HEXAGON

- Breakout spaces in need of comfort? The Hexagon ottoman is just the piece.
- W1380 x D1200 x H450

ONLY
\$789
ELEHEXOT



PEBBLE OTTOMANS

- PEBBSMALL D450 x H390 **\$209**
- PEBBMEDIUM D650 x H390 **\$309**
- PEBBLARGE D850 x H390 **\$499**

FROM
\$209
PEBBSMALL

IN THE ROUND

Twist...Curve...Shape.

With "In the Round" you can create a multitude of configurations. Perfect for libraries and collaboration spaces. Popular settings include C-shape and snake shape.

- Box construction with 80mm and 35mm glides
- Layout service available

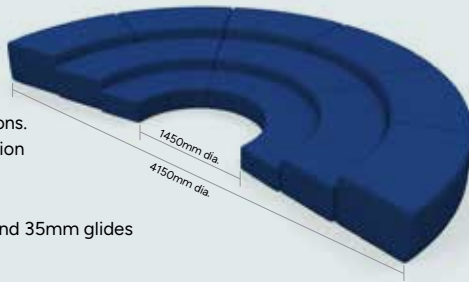

FULL QUARTER
\$3256
ITRQTR04



MANY Colours available POA

- Inner High - 600H x 450D ITRINHIG01 (not pictured)
- Inner Low - 300H x 450D ITRINLOW01
- Middle - 450H x 450D ITRMIDMED01
- Outer High - 600H x 450D (Set of 2) ITROUTHIG02
- Outer Low - 300H x 450D (Set of 2) TROUTLOW02 (not pictured)



BURRA OTTOMAN

Box construction, high density foam



Rectangular size options:

900W x 450H mm BUR9045 / 1350W x 450H mm BUR1350

FROM
\$769
BUR9045



FROM
\$599
BUR4545

Square size options:

450W x 450H mm BUR4545 / 600W x 600H mm BUR6060



MANY Colours available POA



SIT DRUM OTTOMAN

ONLY
\$429
BRIS450RD

- 450H x 450mm dia.
- Full foam on 18mm plywood base with 35mm glides



MANY Colours available POA

ROUND OTTOMAN



FOAMY SEATPADS & TROLLEY



- Trolley made from 18mm melamine
- On castors
- Seat pads sold separately

Trolley 450D **\$509** FOAMSPCAD450
600D **\$589** FOAMSPCAD600
Pads 450dia. x 50mm thick **\$109** FOAMSP45
600dia. x 90mm thick **\$199** FOAMSP60
High density foam

FOAMY NINJA BLOCKS

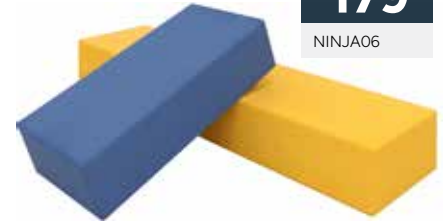

FROM
\$179
NINJA06

Students can let their imagination run wild creating their own environment. Use as seats, worksurfaces or as building blocks.

- Full high density foam block
- Very versatile
- Minimum 6 blocks per purchase
- Available in many vinyl colours and fabrics available
- Small: 600L x 300D x 150H mm **\$179** NINJA06
- Large: 1200L x 300D x 150H mm **\$239** NINJA12



MANY Colours available POA



STAY CUBE OTTOMAN

ONLY
\$409
BRIS450SQ

- 450H x 450W x 450D
- Full foam on 18mm plywood base with 35mm glides



MANY Colours available POA



MANY Colours available POA

CLEARANCE

SAVE UP TO 28%

PODZ CUBEE

ONLY
\$134



• 470mm wide

ALSO AVAILABLE IN FABRIC \$POA

PODZ RONDO

- Ball-bearing castors with rubber wheels
- 480mm diameter
- 460mm high

ONLY
\$141

SAVE \$48 PDROND



WHILE STOCKS LAST SPECIAL

PODZ GEO

ONLY
\$314



• 1300mm wide

PODZ CENTRIC



• 1120mm wide



ONLY
\$374
SAVE \$195 PDCENT

PODZ FLOWER PACKAGE

5 PETALS & CENTRE

THE LOT
\$899

SAVE \$355 PDFLOWER



- 1280mm x 1230mm
- Five heavy duty castors per piece

MIX & MATCH VINYL COLOURS

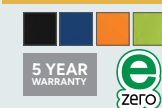

LILYPAD
\$49

SAVE \$20 PDLPCENT



PODZ TROLLEY



EXTRA LARGE
610MM DIA.
50MM THICK

TROLLEY \$179
PDLPTROLLEY
• 1120mm high
• Holds 11

SAVE UP TO 28%

Habitat Range

HABITAT D1



FROM
\$4416
HABITATD1

- Feel the embrace of the Habitat D1 as you break away for group based activities or browse from the book shelves.
- W3540 x D2295 x SH450

Erasable top
also available
POA\$

HABITAT D2



FROM
\$3278
HABITATD2

- Habitat D2 is an amphitheatre style information hub with two levels of seating. 900 H.
- W3540 x D1770 x SH450
- Stools not included

HABITAT D3



FROM
\$5996
HABITATD3

- The Habitat Cove is a cosy, inclusive and friendly setting for collaborative meetings with breakout seating beyond.
- W4785 x D3540 x SH450
- Circo 600 ottoman not included (PDCIRC06 **\$249**)
- Discus table not included (DISCTB1000/1200 **From \$249**)

HABITAT MEADOW



FROM
\$2607
HABITATMEADOW

MANY
Colours
available
POA
See page 34

- This informal yet comfortable Habitat Meadow lounge setting feels right at home in any school breakout zone.
- W2250 x D1050 x SH450
- Pebble table not included (PEBB400 **\$219**)

HABITAT STREAM



FROM
\$5996
HABITATSTREAM

- Let learning flow with the Habitat Stream, designed to host small casual meetings, breakout activities and group activity.
- W4572 x D1780 x SH450
- Rondo ottoman not included (PDROND05 **\$199**)
- Discus table not included (DISCTB1000/1200 **From \$249**)

Ask about Habitat Flexi available with castors and new low height bench (750mm H)



Ideal for schools

Ask our Education Specialist about the huge range of Habitat options and configurations

Flexi version:
HBxCVx / HBxSTx

1000s of configurations

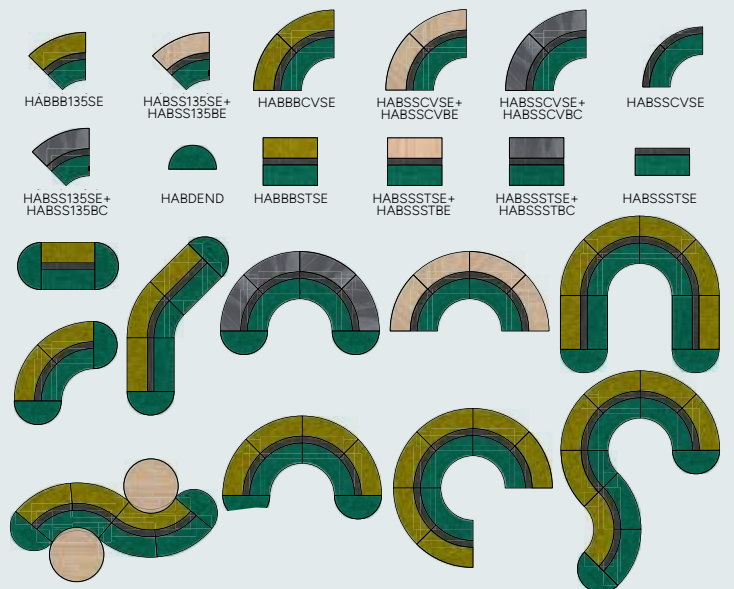

Reconfigurable for flexible spaces



ORIGAMI SUMI

- Sumi is ideal for foyers, libraries, staff rooms and admin areas to create a comfortable place to seek respite.
- W2250 x D750 x SH450

PRODUCT	CODE	SIZE (mm)	PRICE (EACH)
Origami Corner Lounge	1 x ORIG01LC	W750 x D750 x SH450	\$739
Origami Two Seat Half Lounge	1 x ORIG02LL	W1500 x D750 x SH450	\$899



ORIGAMI NESUTO

- Origami Nesuto helps to zone space whilst offering a place to unwind, socialise or settle in to read or work.
- W3600 x D1500 x SH450
- Plants not included

PRODUCT	CODE	SIZE (mm)	PRICE (EACH)
Origami Corner Lounge	4 x ORIG01LC	W750 x D750 x SH450	\$739
Origami Two Seat Lounge	2 x ORIG02L	W750x D750 x H450	\$1029
Planta 1500	2 x PLHIGH1500	W1500 x D300 x H800	\$549



ORIGAMI OKORU

- The Origami Okoru setting creates a space for casual meetings, teamwork, private study or socialisation.
- W4800 x D1500 x SH450
- Plants not included

PRODUCT	CODE	SIZE (mm)	PRICE (EACH)
Origami Two Seat Lounge	4 x ORIG02L	W1500 x D750 x SH450	\$1029
Pebble	2 x PEBB400	W400/350 x D400 x H650	\$219
Planta 1500	1 x PLHIGH1500	W1500 x D300 x H800	\$549



ORIGAMI BOTO

- Use Origami Boto at your learning facility in open floor plan spaces, libraries and senior spaces. Add a Pebble Table!
- W3000 x D1500 x SH450

PRODUCT	CODE	SIZE (mm)	PRICE (EACH)
Origami Two Seat Lounge	2 x ORIG02L	W1500 x D750 x SH450	\$1029
Origami Fan Ottoman	4 x ORIG01FAN	W750x D750 x H450	\$409
Pebble	1 x PEBB400	W400/350 x D400 x H650	\$219



ORIGAMI ORU

- Oru invites you to take a seat whilst waiting in reception. Ideal for corner spaces but easily reconfigured.
- W2250 x D2250 x SH450

PRODUCT	CODE	SIZE (mm)	PRICE (EACH)
Origami Two Seat Lounge	2 x ORIG02L	W1500x D750 x SH450	\$1029
Origami Single Lounge	1 x ORIG01LC	W750 x D750 x SH450	\$739



ORIGAMI KONA

- Origami Kona creates space for lounging, conversing and meeting with its design inspiring creativity and connection.
- W4800 x D1500 x SH450
- Plants not included

PRODUCT	CODE	SIZE (mm)	PRICE (EACH)
Origami Corner Lounge	2 x ORIG01LC	W750 x D750 x SH450	\$739
Origami Two Seat Lounge	2 x ORIG02L	W1500x D750 x SH450	\$1029
Origami Single Seat Lounge	2 x ORIG01L	W7500 x D750 x SH450	\$609
Pebble	2 x PEBB400	W400/350 x D400 x H650	\$219
Planta 1500	1 x PLHIGH1500	W1500 x D300 x H800	\$549

ORIGAMI COFFEE TABLES



	PRODUCT	CODE	SIZE (mm)	PRICE
A	Origami Square Coffee Table	ORIGCTS	W750 x D750 x H450	\$219
B	Origami Tera Coffee Table	ORIGCTO	W750 x D750 x H450	\$239
C	Origami Fan Coffee Table	ORIGCTFAN	W750 x D750 x H450	\$229

PLANTA

PRODUCT	CODE	SIZE (mm)	PRICE
Planta 1200	PLLOW1200	W1200 x D300 x H450	\$289
Planta 1200	PLHIGH1200	W1200 x D300 x H800	\$389
Planta 1370	PLLOW1370	W1370 x D300 x H450	\$329
Planta 1370	PLHIGH1370	W1370 x D300 x H800	\$499
Planta 1500	PLLOW1500	W1500 x D300 x H450	\$369
Planta 1500	PLHIGH1500	W1500 x D300 x H800	\$549

*Plants not provided.
Live plants require self-watering system - not provided.



The Elements® Range is denoted by an angular profile for defined spaces



ELEMENTS® F1

- Feel the embrace of Elements F1 as you break away for group based activities or retreat for a spot of reflection and focus.
- W3300 x D2798 x SH450

PRODUCT	CODE	SIZE (mm)	PRICE (EACH)
Elements Trapezoid Lounge 2 seat	4 x ELETRAP02L	W1370 x D600 x SH450	\$779
Bookcase	4 x ELETRAP02BC	W1827 x D450 x H720	\$639



ELEMENTS® F2

- With its external benches, Elements F2 creates a soft hideaway with angled lines and modern appeal for open spaces.
- W3300 x D2798 x SH450
- Chairs not included

PRODUCT	CODE	SIZE (mm)	PRICE (EACH)
Elements Trapezoid Lounge 2 seat	4 x ELETRAP02L	W1370 x D600 x SH450	\$779
Bench	4 x ELETRAP02BE	W1386 x D450 x H720	\$399



ELEMENTS® F3

- With its upholstered back, Elements F3 creates a focussed group space. iDisc Hex reflects the angular appeal.
- W2400 x D2070 x SH450

PRODUCT	CODE	SIZE (mm)	PRICE (EACH)
Elements Trapezoid Lounge 2 seat	4 x ELETRAP02L	W1370 x D600 x SH450	\$779
Hexagon Discus Table	1 x DISCTBHEX12	W1386 x D450 x H720	\$399



ELEMENTS® ESKER

- Create a sense of open plan privacy with the Elements Esker. Designed for small, casual meetings, breakout and study.
- W3460 x D3600 x SH450

PRODUCT	CODE	SIZE (mm)	PRICE (EACH)
Elements Trapezoid Lounge 3 seat	6 x ELETRAP03L	W2075 x D600 x SH450	\$1129



ELEMENTS® LYNX

- Create dynamic work areas with the Elements Lynx setting. Includes 1x Hex ottoman and 4x Large Trapezoid Lounges.
- W3600 x D2770 x SH450

PRODUCT	CODE	SIZE (mm)	PRICE (EACH)
Elements Trapezoid Lounge 3 seat	4 x ELETRAP03L	W2075 x D600 x SH450	\$1129
Elements Hexagon Ottoman	1 x ELEHEXOT	W1380 x D1200 x H450	\$789



ELEMENTS® PINGO

- The Elements Pingo setting combines seating with resource storage. Angular design softened by quality upholstery.
- W6810 x D3300 x SH450

PRODUCT	CODE	SIZE (mm)	PRICE (EACH)
Elements Trapezoid Lounge 2 seat	6 x ELETRAP02L	W1370 x D600 x SH450	\$779
Bookcase	6 x ELETRAP02BC	W1827 x D450 x H720	\$639
Hexagon Discus Table	2 x DISCTBHEX12	W1386 x D450 x H720	\$399

VE E0 Melamine Colours

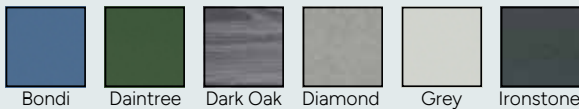

Bondi Daintree Dark Oak Diamond Grey Ironstone



Light Oak Natural Oak Pindan Storm White Zincworks Writable

VE Fabric Colours

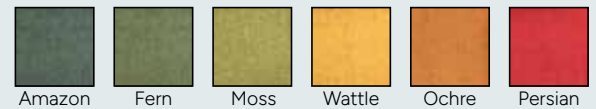

Amazon Fern Moss Wattle Ochre Persian

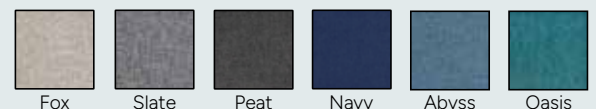

Fox Slate Peat Navy Abyss Oasis

7 YEAR WARRANTY

MANY Colours available POA

Elements Range

Ask about approved products
SOA QED
104526

MANY
Colours
available
POA

See page 34



ONLY
\$779
ELETRAP02L



ONLY
\$1129
ELETRAP03L



ONLY
\$389
ELEDIAOT

ELEMENTS® TRAPEZOID LOUNGE

- The comfortable 2 seat Elements Earth Trapezium Sofa allows you to create interesting shapes with its angular design.
- W1370 x D600 x SH450

ELEMENTS® TRAPEZOID LOUNGE

- Soften a space with the plush 3 seat Elements Earth Trapezoid sofa, big on comfort with a variety of ways to configure.
- W2075 x D600 x SH450

ELEMENTS® DIAMOND OTTOMAN

- The Elements Earth Diamond, with its angular design is an interesting addition to any space needing seated comfort.
- W1100 x D600 x H450



ONLY
\$249
ELETRIOT



ONLY
\$499
ELETRAP02B



ONLY
\$779
ELETRAP03B

ELEMENTS® TRIANGLE OTTOMAN

- Cute and comfy, our angular Elements Earth Triangles are small in size yet big in appeal and comfort.
- W680 x D590 x H450

ELEMENTS® TRAPEZOID OTTOMAN

- The small angular 2 seat Trapezoid ottoman has lots of charm. Configure it with other pieces from the range or pair them up.
- W1370 x D600 x H450

ELEMENTS® TRAPEZOID OTTOMAN

- The large 3 seat Trapezoid ottoman allows you to spread out, be in against a wall or in the centre of a room.
- W2075 x D600 x H450



ELEMENTS® KARST

- Elements Karst provides comfortable, durable seating in reception, libraries and staff rooms. Includes Pebble Table.
- W2075 x D1200 x SH450



ELEMENTS® FOREST

- The Elements Forest setting combines informal seating, 2x convenient triangle tables and the greenery of Planta.
- W3425 x D1500 x SH450
- Plants not included



ONLY
\$789
ELEHEXOT

ELEMENTS® HEXAGON OTTOMAN

- Breakout spaces in need of comfort seating? The Elements Hexagon Ottoman is just the piece you've been looking for.
- W1380 x D1200 x H450

PRODUCT	CODE	SIZE (mm)	PRICE (EACH)
Elements Trapezoid Lounge 3 seat	2 x ELETRAP03L	W2075 x D600 x SH450	\$1129
Pebble	1 x PEBB400	W400/350 x D400 x H650	\$219

PRODUCT	CODE	SIZE (mm)	PRICE (EACH)
Elements Trapezoid Lounge 3 seat	4 x ELETRAP03L	W2075 x D600 x SH450	\$1129
Elements Triangle Table	2 x ELETRIOT	W650 x D562 x H450	\$259
Planta 1370	2 x PLHIGH1370	W1370 x D300 x H800	\$499



ONLY
\$259
ELETRIOT

ELEMENTS® TOR



- W3464 x D1800 x H450

PRODUCT	CODE	SIZE (mm)	PRICE (EACH)
Elements Hexagon Ottoman	3 x ELEHEXOT	W1380 x D1200 x H450	\$789
Pebble	1 x PEBB400	W400/350 x D400 x H650	\$219

ELEMENTS® TRIANGLE TABLE

- The Elements Modular Lounge system includes an angular occasional table giving you the convenience of a table top.
- Strong plywood construction
- W650 x D562 x H450



ONLY
\$269
ELEATRIOT



ONLY
\$409
ELEADIAOT



ONLY
\$609
ELEATRAPO2B



ONLY
\$999
ELEAHEXOT

ELEMENTS® TRIANGLE

- Short on space? Then the Elements Triangle is for you! With its light footprint, it provides contemporary casual seating.
- W680 x D590 x H450

ELEMENTS® DIAMOND

- Elements Diamond is an angular shaped ottoman ideal for modern spaces to create drama and excitement.
- W1100 x D600 x H450

ELEMENTS® TRAPEZOID 2 SEAT

- Angular, yet comfortable, the Elements Trapezoid is light and modern and right at home in any breakout space.
- W1370 x D600 x H450

ELEMENTS® HEXAGON

- Elements Hex Ottoman is a cute addition to any space.
- W1380 x D1200 x H450



ELEMENTS® TRAPEZOID 3 SEAT

- Ideal against a wall or doubled up as the centrepiece of a room, the Elements Large Trapezium is generously sized.
- ELEATRAPO3B W2075 x D600 x H450 **\$989**



Combine and reconfigure to update your space

ELEMENTS® NIMBUS

- W1378 x D1200 x H450
- 1 x ELEATRAPO2B W1370 x D600 x H450 **\$609**
- 1 x ELEADIAOT W1100 x D600 x H450 **\$409**
- 1 x ELEATRIOT W680 x D590 x H450 **\$269**



ELEMENTS CUMULUS

- W2400 x D1684 x H450
- 2 x ELEAHEXOT W1370 x D600 x H450 **\$999 (each price)**
- 1 x ELEADIAOT W1100 x D600 x H450 **\$409**



NOVA + PEBBLE

- These modular little lounges are easy to reconfigure to suit groups of any size. Pebble tables provide a handy surface.
- 4 x NOVA01 W580 x D680 x SH400 **\$529 (each price)**
- 2 x PEB400 W400 x D400 x H650 **\$219 (each price)**



ONLY
\$529
NOVA01

NOVA SINGLE SEAT LOUNGE

- With clean lines and voluptuous cushioning, this comfy lounge is a popular choice.
- W580 x D680 x SH400



ONLY
\$839
NOVA02

NOVA TWO SEAT LOUNGE

- The cosy Nova Lounge with its clean lines and voluptuous cushioning is very versatile.
- W1200 x D680 x SH400
- Table not included

MANY
Colours
available
POA

See page 34

9 Huge locations throughout QLD & NSW or BUY ONLINE at empirefurniture.com.au

WOOLLOONGABBA	61 Ipswich Rd Woolloongabba	4102	P 3132 0605	gabba@empirefurniture.com.au
SYDNEY	36 Parramatta Rd (cnr Mons St) Lidcombe	2141	P 9000 1564	sydney@empirefurniture.com.au
ROCKLEA (FACTORY OUTLET)	Gate 1, 51-63 Heaton Street, Rocklea	4106	P 3179 6122	rocklea@empirefurniture.com.au
VIRGINIA	1928 Sandgate Rd Virginia	4014	P 3477 9692	virginia@empirefurniture.com.au
SOUTHPORT	180 Scarborough St Southport	4215	P 5625 7560	southport@empirefurniture.com.au
SUNSHINE COAST	Shop E, 224 Nicklin Way Warana	4575	P 5300 2663	sunshine@empirefurniture.com.au
ROCKHAMPTON	211 East St Rockhampton	4700	P 4800 3003	rockhampton@empirefurniture.com.au
MACKAY	2B Victoria St Mackay	4740	P 4800 4085	mackay@empirefurniture.com.au
TOWNSVILLE	233 Ingham Rd Garbutt	4814	P 4800 4373	townsville@empirefurniture.com.au



SCAN HERE
FOR
SHOWROOM
DETAILS



PEFC™
PEFC/21/31/119