

it's easier with **empire** office furniture

empirefurniture.com.au EST 1982

FEDA (Full Expensing of Depreciating Assets)

Businesses can now claim a 100% tax deduction (this financial year) on Office Furniture purchases.

Ask your Accountant or refer to ato.gov.au to check your eligibility.

**N
E
W**

BEST IN ELECTRIC HEIGHT ADJUSTABLE DESKS



Altura
SIT-STAND DESK

FROM \$839
ALTD1275

2 MOTORS

- Market leading weight rating 210kg (3 motors) & 135kg (2 motors)
- Frame colour - black, white or silver
- Anti-collision safety feature
- 4 memory pre-sets

See page 10

empire 10 YEAR WARRANTY
FRAME & MOTORS



ONLY \$549
UPTD1575/C

1 MOTOR

"UPTOWN" Sit-Stand
...at Downtown Prices!

See page 11

empire 5 YEAR WARRANTY

ERGOFORM MESH

INC. ARMS

\$219

SAVE \$100
BLACK BASE
ERGF22M

See page 30



FLOW NO ARMS

\$289

SAVE \$10
FLOW23

See page 30



MET EXECUTIVE

\$399

SAVE \$50
ARMS INCL.
METT12

See page 30



ERGOHUMAN

HIGH BACK

\$749

SAVE \$220
ERHU12S

See page 31



Citi SYSTEM



BACK-TO-BACK 4 PERSON

\$320*

PER PERSON
CTXBB41575

ALL-STEEL MOBILE PEDESTAL

ONLY \$179

SAVE \$40
MPBS2DF

LOCKABLE

See page 2

empire 10 YEAR WARRANTY

- Available in 2, 4 & 6 person configurations
- Full range pages 12-16

*Price includes desk frame/top & screen. Accessories not included.

DET 68449 SOA **Queensland Government**
One of the Preferred Suppliers for Office, Education and Health Furniture
Whole of Government - DET QLD SOA 68449.
Contact us for Approved Products List. www.empirefurniture.com.au/soa

FOR NSW **New South Wales Government**
NSW Government Office Furniture Scheme SCM0771
Advanced Registered Supplier including the new category
Flexible Learning Furniture. Contact us for Approved Products List.

2-3 Steel Storage	4-5 Shipshape Office Furniture	6-7 New Essence 45 Office Furniture	8-9 Fitout Solutions	10-11 Height Adjustable Desking & Benches	12-16 Citi System Furniture	17-19 Reception & Boardroom Tables	20-24 Education, Whiteboards & Tables	25 Sunrise & Benchmark Modular Lounges	26-27 Konfurb & Moto ABW Ranges	28-29 Break Out & Reception Seating	30-35 Office Chairs
-----------------------------	--	---	--------------------------------	---	---------------------------------------	--	---	--	---	---	-------------------------------

ALL-STEEL MOBILE PEDESTAL



LOCKABLE ONLY
\$179
 SAVE \$40
 MPBS2DF

SAVE 23% OFF

- 590H x 390W x 500D
- Fully assembled
- 2 drawers plus file
- Heavy duty ball bearing runners on file drawer
- Silver, White, Graphite Ripple or Black Ripple



Citi MOBILE PEDESTAL



ONLY
\$209
 SAVE \$30
 CTMP2DF

- 597H x 390W x 500D
- Lockable
- 2 drawer plus file
- 4 colour handles - Green, Red, Blue or Black
- Heavy-duty ball-bearing runners on file drawer



SLIMLINE MOBILE PEDESTAL



ONLY
\$239
 MPGOS2DF

- Available in Black or White
- 610H x 300W x 500D
- Ball Bearing Runners
- Flush Front
- Fifth Wheel on Drawer



B&W SLIM-LINE MOBILE PEDESTAL

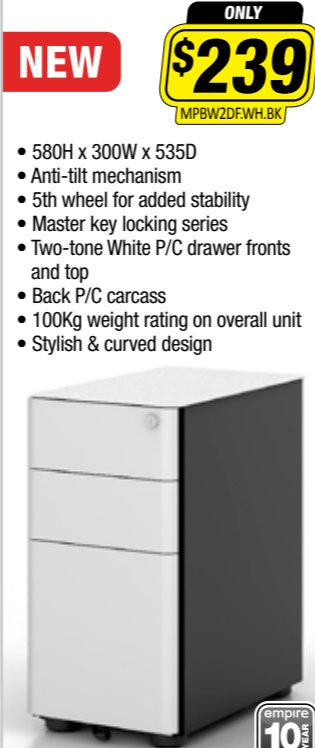

NEW ONLY
\$239
 MPBW2DFWH.BK

- 580H x 300W x 535D
- Anti-tilt mechanism
- 5th wheel for added stability
- Master key locking series
- Two-tone White P/C drawer fronts and top
- Back P/C carcass
- 100Kg weight rating on overall unit
- Stylish & curved design



FILING CABINET



LOCKABLE
4 DRAWER
\$359
 1300mm H
 FCBS4D

3 DRAWER
\$319
 1010mm H
 FCBS3D

2 DRAWER
\$259
 710mm H
 FCBS2D

- 460W x 620D
- Fully assembled
- Full extension ball bearing runners
- 4 durable powder coat colours: Graphite Ripple, White, Grey & Black Ripple



LOCKERS (Silver Grey)



305W x 1827H x 460D
Bank of 1
 Single door LKBS301.SG **\$189**
 2 door LKBS302.SG **\$209**
 4 door LKBS304.SG **\$219**

380W x 1827H x 460D
Bank of 1
 Single door LKBS381.SG **\$219**
 2 door LKBS382.SG **\$229**
 4 door LKBS384.SG **\$239**

- Comes with latch-lock (use your own padlock)
- Also available in banks of 2 or 3



Also available
KEY LOCKS
 add \$10
 per door
 PTBS02

We do customised lockers!



TOAST RACKS \$35
 ① Wrap Around FSTR02
 ② Box Style FSTR06

TAMBOUR DOOR CUPBOARDS

PLANTER BOX
 • 200mm high
 • Holds 4 x 200mm diameter pots
 • Perforated steel (white)

For artificial plants **\$229** PLBS1120
 For real plants including drip tray **\$257** PLBS1120DT

PLANTS SOLD SEPARATELY

Now with drip tray!

ARTIFICIAL PLANTS \$199
 • 4 pots and moss base

Ⓐ **LOW FOLIAGE** PLBSLOW1
 Ⓑ **TALL FOLIAGE** PLBSTAL1



4 SHELVES
\$949
 2000mm H
 TDBS2011

2 SHELVES
\$679
 SAVE \$10
 1200mm H
 TDBS1211

2 SHELVES
\$639
 1010mm H
 TDBS1011

White only



- Fully assembled
- 1120W x 460D
- Lockable
- Adjustable shelves included
- Available in White with White doors or Graphite Ripple with Grey doors
- Attractive roller shutter doors, retract inside the cabinet
- Extra Shelf **\$30** TDBSSH

PIGEON HOLE UNITS



20 HOLE
\$329
 SAVE \$20
 PHBS20

40 HOLE
\$519
 SAVE \$30
 PHBS40

- 20 hole, 1010H x 1040W x 385D
- 40 hole, 1827H x 1040W x 385D
- White & Graphite Ripple
- All steel construction



LATERAL FILING CABINETS

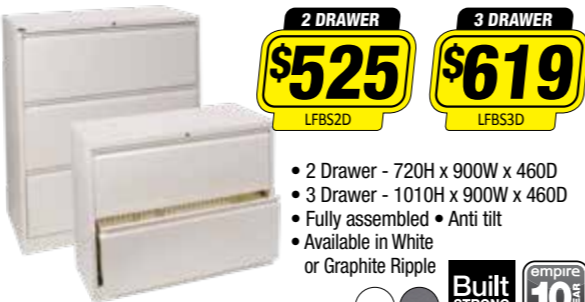

2 DRAWER
\$525
 LFBS2D

3 DRAWER
\$619
 LFBS3D

- 2 Drawer - 720H x 900W x 460D
- 3 Drawer - 1010H x 900W x 460D
- Fully assembled
- Anti tilt
- Available in White or Graphite Ripple



WOULD YOU LIKE FILES WITH THAT?
\$50 inc GST ENSF50

- Box of 50 files
- Made from 100% recycled board
- Smooth runners for quiet gliding of files



METAL STATIONERY CUPBOARDS



4 SHELVES
\$419
 2100mm H
 SCBS21

3 SHELVES
\$349
 1827mm H
 SCBS18

2 SHELVES
\$269
 1010mm H
 SCBS10

EXTRA SHELF (INCLUDING CLIPS)
\$30 SCBSSH

- 905W x 460D
- Adjustable shelves
- Three point locking mechanism
- Priced in White, Graphite Ripple & Silver Grey



INDUSTRIAL STEEL SHELVING



ONLY
\$299
 SAVE \$20
 SSBS21.SG

EXTRA SHELF \$30 SCBSSH

- 4 adjustable shelves
- 2100H x 905W x 460D
- Silver Grey



INDUSTRIAL QUALITY LONG SPAN SHELVING



INITIAL
\$669
 1900mm H
 LSBS18I

EXTENSION
\$399
 950mm W
 LSBS09E

2100H x 600D
 1000W Initial **\$479** LSBS09I
 950W Extension **\$399** LSBS09E
 1900W Initial **\$669** LSBS18I
 1850W Extension **\$589** LSBS18E

EXTRA ADJUSTABLE SHELF (Pack of 2)

900W **\$120** LSBS09A
 1800W **\$210** LSBS18A



- High quality all steel construction
- Massive 350kg per shelf capacity
- Supplied with 2 adjustable shelves and 2 fixed shelves as standard





How healthy is your office?

zero

EXCLUSIVE TO EMPIRE
Our SHIPSHAPE range uses board containing near to zero formaldehyde...Does yours?

SHIPSHAPE

- E0 Environmentally Friendly board
- 10 year commercial warranty
- Flat-packed or fully assembled

- 100s of products (3 col combos) for quick delivery
- Metal-sided drawers and runners with solid bases
- Strong cammed-construction for easy assembly
- Ball-bearing full extension runners on file drawers
- 25mm on 18mm solid melamine construction
- 2mm hard-wearing rigid PVC edge
- 2 cable entry points in all desks (excluding P-Desk)



COLOURS: Red Cherry/Ironstone, Select Beech/Ironstone, White/Silver

We will beat any written quote...Empire always guarantees the lowest prices*

A BOOKCASE HUTCH

CODE	SIZE	PRICE
SHHU12	1200W x 320D x 1075H	\$249
SHHU15	1500W x 320D x 1075H	\$279
SHHU18	1800W x 320D x 1075H	\$299

B STRAIGHT DESK (Open) - 3/4 Modesty

ADVANCED TESTED & CERTIFIED

CODE	SIZE	PRICE
SHDK1260	1200W x 600	\$149
SHDK1575	1500W x 750D	\$179
SHDK1590	1500W x 900D	\$205

C RETURN (Open)

CODE	SIZE	PRICE
SHRT09	900W x 600D x 727H	\$119
SHRT12	1200W x 600D x 727H	\$129

OPTIONAL DRAWER BOX
ADD \$120 SHDB1DF/SHDB3D

- Available in left or right (Universal)

D FITTED DRAWER BOX

CODE	SIZE	PRICE
D1 SHDB3D	3 DRAWER	\$130
D2 SHDB1DF	1 DRAWER + FILE	\$130

- Full extension ball bearing runner on file drawer
- 450H x 463W x 473D

E CORNER WORKSTATION (Open)

ADVANCED TESTED & CERTIFIED

CODE	SIZE	PRICE
SHWS61212	1200 x 1200 x 600	\$329
SHWS61215	1200 x 1500 x 600	\$309
SHWS61218	1200 x 1800 x 600	\$319
SHWS61515	1500 x 1500 x 600	\$319
SHWS61518	1800 x 1500 x 600	\$325
SHWS61818	1800 x 1800 x 600	\$329

F STORAGE CUPBOARDS (Includes full doors)

CODE	SIZE	LEVELS	PRICE
SHSC09	900H x 900W x 400D	2	\$269
SHSC12	1200H x 900W x 400D	3	\$349
SHSC18	1800H x 900W x 400D	5	\$409

- 3 sizes & 3 colour combos
- 25mm shelves • 18mm back

G DELUXE BOOKCASES

CODE	SIZE	LEVELS	PRICE
SHBC09	900H x 900W x 400D	2	\$179
SHBC12	1200H x 900W x 400D	3	\$209
SHBC18	1800H x 900W x 400D	5	\$279

EXTRA SHELF \$30 SHSH900

H STORAGE CUPBOARDS (Includes half doors)

CODE	SIZE	LEVELS	PRICE
SHSC18HD	1800H x 900W x 400D	5	\$389

- 25mm shelves
- 18mm back

I FILING CABINETS

LOCKABLE FULL EXTENSION BALL BEARING RUNNERS

CODE	SIZE	PRICE
SHFC2D	2 DRW - 750H x 490W x 556D	\$229
SHFC3D	3 DRW - 1066H x 490W x 556D	\$349
SHFC4D	4 DRW - 1385H x 490W x 556D	\$409

SQUARELINE
Square handle is standard on Silver/White items only. Also sold separately.

\$5ea
HANDLE01

M DESK HEIGHT CRENZNA

CODE	SIZE	PRICE
SHCR09	900W x 600D x 725H	\$269

- Hinged doors

N 3 TIER MOBILE CABINET

CODE	SIZE	PRICE
SHMOB2T	600W x 450D x 675H	\$159

- White/Silver only

O CRENZNA

CODE	SIZE	PRICE
SHCR12	1200W x 725H x 450D	\$279
SHCR15	1500W x 725H x 450D	\$309
SHCR18	1800W x 725H x 450D	\$389

- Sliding doors

P MOBILE PEDESTAL

CODE	SIZE	PRICE
M1 SHMP2DF	2 DRW + FILE	\$199
M2 SHMP4D	4 DRAWER	\$209

- 470W x 560D x 640H
- Full extension ball bearing runners
- Metal sided drawers
- Ironstone or White

J MEETING TABLE

CODE	SIZE	PRICE
SHMT1000	1000mm diameter	\$189

- X-base

K COFFEE TABLE

CODE	SIZE	PRICE
K1 SHCT06	600W x 600D x 430H	\$119
K2 SHCT09	900W x 600D x 430H	\$89

- White only

L DELUXE HORIZONTAL BOOKCASES

CODE	SIZE	PRICE
L1 SHBC0918	900H x 1800W x 400D	\$429
L2 SHSC0918	WITH DOORS	\$619

SHIPSHAPE RECEPTION HOB

1800mm x 400mm

ONLY \$115
SHRH18

- 1800W x 400H x 320D
- Convert any 1800L desk into an instant reception counter
- *Desk not included

DESK ACCESSORIES STANDARD MONITOR STAND
500W x 350D x 150H

ONLY \$69
SHFLIP

ONLY \$55
SHMSREC

- White only

MOBILE CPU SLIDE

NEW LOW PRICE

FROM \$53
SHCPU

- Suits CPUs up to 255W x 570D
- Strong cammed construction for easy assembly
- Ironstone only

FLIP DESK ORGANISER

Flip 90° Ironstone only
Flip - 320W x 320W x 450H

ONLY \$69
SHFLIP

SHIPSHAPE RANGE TOP SELLERS Best Price Guarantee

B STRAIGHT DESK (OPEN)



1500W X 750D
\$179
NO DRAWERS
SHDK1575

1800W X 750D
\$195
NO DRAWERS
SHDK1875

OPTIONAL
DRAWER BOX
\$130
SHDB1DF

• See page 4 for more details



E CORNER WORKSTATION (OPEN) 1800 X 1800 X 600D

ONLY
\$329
SHWS61818



OPTIONAL
2 DRAWER +
FILE MOBILE PED
\$199 SHMP2DF



D-END BOARDROOM TABLE

ONLY
\$389
SHBT2412D

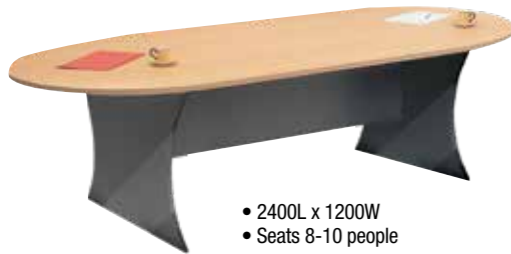

- 2400L x 1200W
- Seats 8-10 people

BOAT SHAPE BOARDROOM TABLE

- 3000L x 1200D
- 2 piece top
- Seats 10-12 people
- Scalloped base

ONLY
\$579
SHBT3012B



The All New Essence 45 Range

Ask about approved products
DET 68449 SOA

PH: 1300 400 521
empirefurniture.com.au

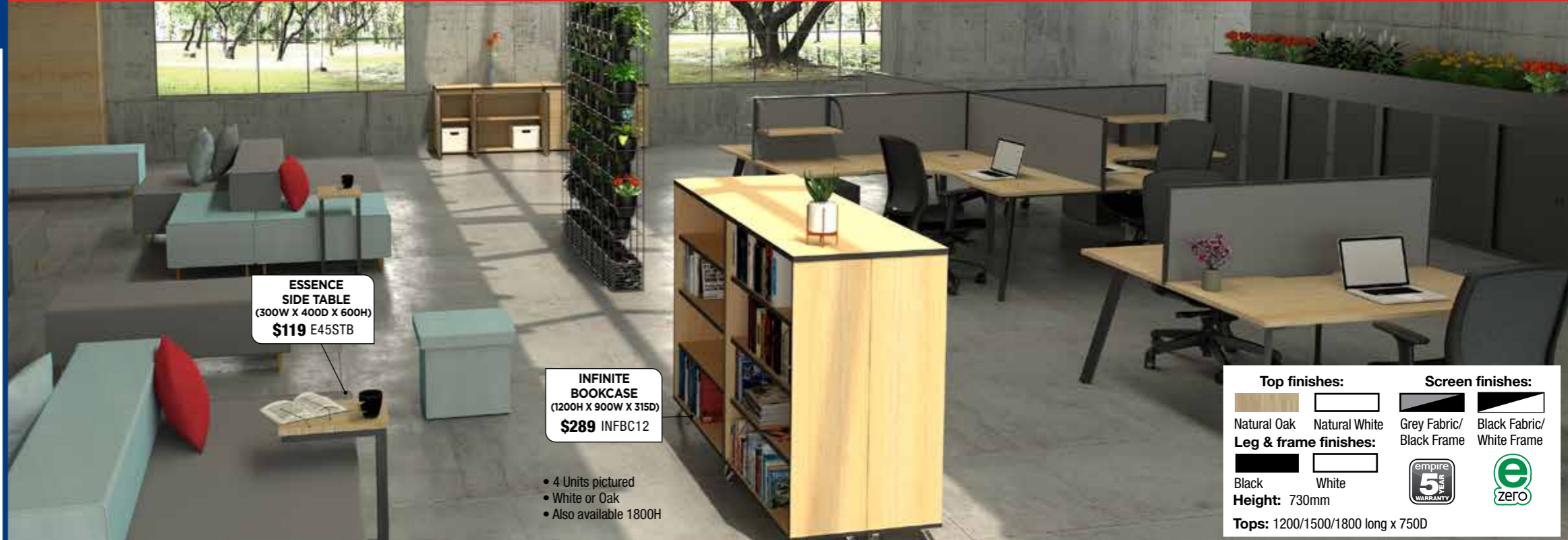

ESSENCE
SIDE TABLE
(300W X 400D X 600H)
\$119 E45STB

INFINITE
BOOKCASE
(1200H X 900W X 315D)
\$289 INFBC12

- 4 Units pictured
- White or Oak
- Also available 1800H

Top finishes:		Screen finishes:	
Leg & frame finishes:			
Height: 730mm			
Tops: 1200/1500/1800 long x 750D			



ESSENCE 45 DESK



- 1050mm high Bar Table also available 1800 x 750.
- **\$419** E45BT1875

- Top Size - 1200 x 750
- 410x50mm Scallop for cable access

ONLY
\$349
E45SS11275W.OAK

Code	Top size (mm)	Price
E45SS11275	1200 x 750D	\$349
E45SS11575	1500 x 750D	\$359
E45SS11875	1800 x 750D	\$389

- Also available with black or grey screen

ESSENCE 45 BACK-TO-BACK WORKSTATION (WITH SCREEN)

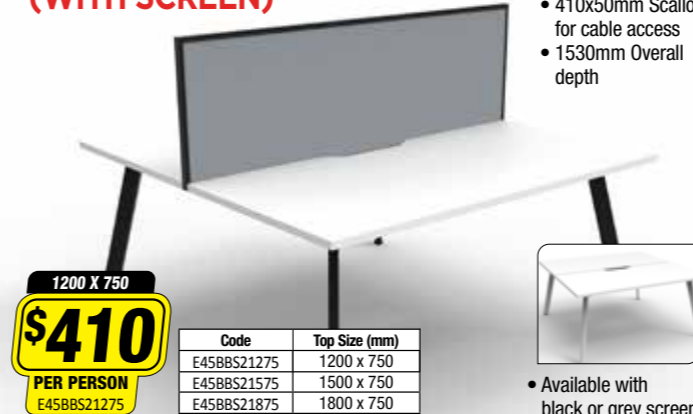

- 410x50mm Scallop for cable access
- 1530mm Overall depth

1200 X 750
ONLY
\$410
PER PERSON
E45BBS21275

Code	Top Size (mm)
E45BBS21275	1200 x 750
E45BBS21575	1500 x 750
E45BBS21875	1800 x 750

- Available with black or grey screen

ESSENCE 45 4-PERSON 'X' POD WORKSTATIONS (WITH SCREENS)

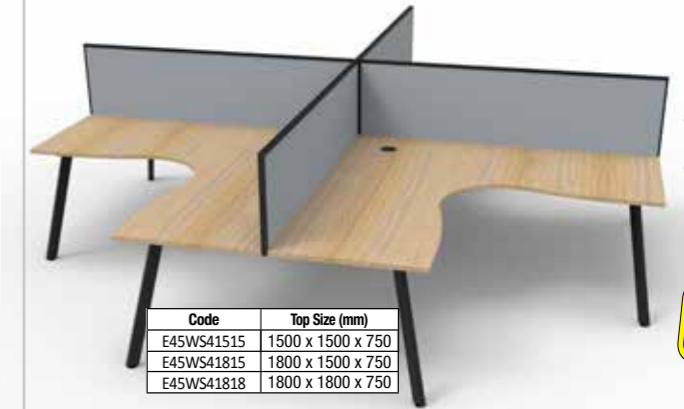

- Screens 500H x 30 thick
- Available with black or grey screen

1500 X 1500
ONLY
\$765
PER PERSON
E45WS41515

Code	Top Size (mm)
E45WS41515	1500 x 1500 x 750
E45WS41815	1800 x 1500 x 750
E45WS41818	1800 x 1800 x 750

ESSENCE 45 CORNER WORKSTATION

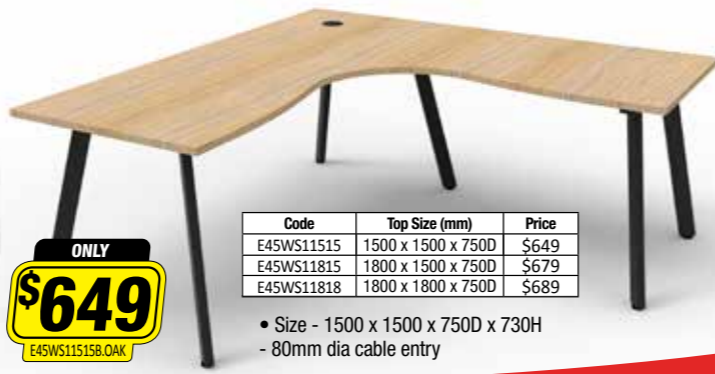

Code	Top Size (mm)	Price
E45WS11515	1500 x 1500 x 750D	\$649
E45WS11815	1800 x 1500 x 750D	\$679
E45WS11818	1800 x 1800 x 750D	\$689

- Size - 1500 x 1500 x 750D x 730H
- 80mm dia cable entry

ONLY
\$649
E45WS11515B.OAK

ESSENCE 45 6-PERSON BACK-TO-BACK WORKSTATION (NO SCREEN)

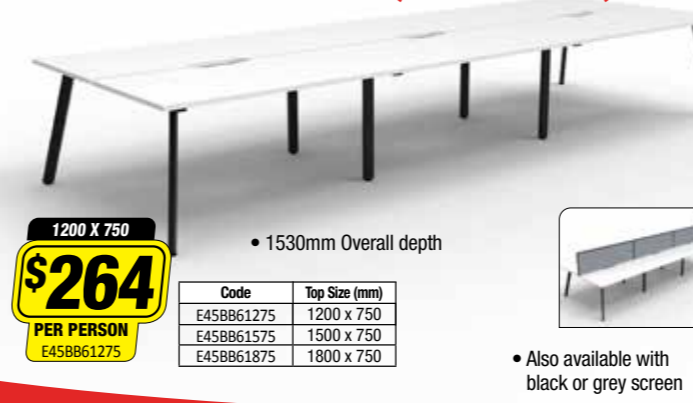

- 1530mm Overall depth

1200 X 750
ONLY
\$264
PER PERSON
E45BB61275

Code	Top Size (mm)
E45BB61275	1200 x 750
E45BB61575	1500 x 750
E45BB61875	1800 x 750

- Also available with black or grey screen

ESSENCE 45 MEETING TABLE



- 900 x 900 x 730H

ONLY
\$329
E45SMT0909

- Round meeting table also available:
900mm dia - **\$329** E45RMT900
1200mm dia - **\$349** E45RMT1200

Project Solutions... easier with empire!

We deliver customised project solutions to meet your design brief & budget.

BACK TO BACK 4P
\$705
PER PERSON
1500 x 750
SU4DSD1575R18



• Bar Leaner
\$1199 SUBL1875

• Nulla Bar Stool
\$479 NULL01T

• Mo-Sync Chair
\$529 MOSY22L.BKF



SEE THE FULL RANGE
IN OUR 88 PAGE 2020
PROJECT WORKSTATIONS
CATALOGUE AT
empirefurniture.com.au



SCAN HERE TO VIEW
THE CATALOGUE

This item
has been
tested by
AFRDI.



The Sustain range with real timber legs looks great ... and is a great price. With natural finish solid oak legs, Sustain includes workstations, desks, meeting tables and coffee tables. Black powder coat rails and connectors and 25mm melamine tops provide for a very sturdy finish. All timber is sourced from an FSC certified sustainable forest, satisfying office furniture needs without compromising sustainability. The Sustain range also has a 15 year full commercial warranty.

Features:

- Natural finish solid oak legs
- Black powder coat rails and connectors
- 25mm melamine tops
- 15 year warranty
- Many sizes and colours



• Modus Chair
\$579 MODU14S.xx

MEETING
\$999
1800 x 900
SUMT1890



BACK TO BACK 2P
\$390
PER PERSON
1500 x 600
SU2DSD1560R18



ELECTRIC HEIGHT ADJUST



TECH ADJUST



FIXED HEIGHT



Stratton Selection

A collection of desk systems that deliver the ultimate in choice, versatility, and affordable style to the modern workplace.

Features:

- Telescopic frame
- Australian made with 10-year warranty

Electric:

- Height range 630-1300mm
- Weight rating (Straight: 160kg, Corner 90: 240kg, Corner 120: 240kg, Dual Bench: 160kg)
- Speed: 40mm per second

Standard:

- Fixed height with worktop 720mm

Tech Adjust:

- Height range 620mm to 950mm, with worktops

Finishes:

- Black or white powdercoated frame
- Select from a large range of standard worktop colours
- Optional extra: 22 custom leg finishes: 13 colours + 9 wood-grain looks.



AUSTRALIA'S FASTEST, QUIETEST & TOUGHEST ELECTRIC DESKS NOW AT EMPIRE

Altura SIT-STAND DESK



RECTANGULAR TOP (2 MOTORS)



Melamine top colours

Code	Size	Price
ALTD1275/C*	1200 x 750mm	\$839
ALTD1575/C	1500 x 750mm	\$849
ALTD1875/C	1800 x 750mm	\$859
ALTD1890/C	1800 x 900mm	\$899

*1200 x 750 available in white top only

SOLID TIMBER TOPS

ALTD1270T	1200 x 700mm	\$999
ALTD1870T	1800 x 700mm	\$1109

• Timber top colours: Natural, Light Oak and Walnut

L SHAPE (3 MOTORS)

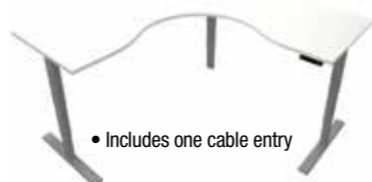

Code	Size	Price
ALTW1212	1200 x 1200 (120°)	\$1269
ALTW1515	1500 x 1500mm	\$1289
ALTW1815S	1800 x 1500mm	\$1309
ALTW1818S	1800 x 1800mm	\$1329

Top



SPECIFICATIONS

- Market leading weight rating 210kg (3 motors) & 135kg (2 motors)
- Height range - min 625mm, max 1270mm
- Individually motorised legs (no exposed mechanism)
- Frame colour - black, white or silver
- Anti-collision safety feature
- 4 memory pre-sets
- Smooth, silent action
- Descends at 35mm per second

LED CONTROL PANEL (INCLUDED)



One touch activation of height mobility makes transitions quick and easy

CABLE UMBILICAL



COMFY MAT ANTI FATIGUE MAT FOR SIT-TO-STAND DESKS

Comfy Mat is an ultra-comfortable anti-fatigue and anti-slip mat. It is made from a thick, dense, durable, one-piece Polyurethane closed cell foam. For use at sit/stand desks, or at check-outs, concierge areas, counters, domestic kitchens, meet & greet areas and workstations.

- Charcoal • PVC free and easy to clean
- Provides unparalleled relief when standing
- Thick Protective Skin • Made in USA
- Anti Microbial Material if used with out shoes
- 12 Year Warranty • Also available - 1200 x 600mm **\$249** COMF1260



PERCH STOOL



"BOB" Desktop Sit-Stand - Electric or Gas lift models

- Unique gas strut provides neutral bouyancy for easy one-hand adjustment
- New X-Lift mechanism for "Straight" up and down
- Superior height range - 410mm travel
- Minimum desktop depth - straight (700mm), corner (no limit)



*Monitor weight

Overall footprint - 900 x 670mm	Max Weight	Code	Gas Lift	Code	Electric Lift
No Monitor Arm	15kg	BOB30G	\$339	BOB30E	\$399
Single Monitor Arm	15kg*	BOB30GM1	\$419	BOB20EM1	\$479
Dual Monitor Arm	8kg*	BOB30GM2	\$499	BOB30EM2	\$559



"UPTOWN" Sit-Stand ...at Downtown Prices!

- 1 motor, 2-Step frame
- Single button control
- 80kg lift capacity
- White frame
- 25mm/sec
- Range: 705mm to 1205mm



Tops

• .SB

• .RC

• .WH

• .BL

• .OAK

• .SV

A & B TOPS

\$549

1500 x 750

UPTD1575/C

A TOPS ONLY

\$589

1800 x 750

UPTD1875/C

AXIOM HIGH BENCH



- 1050mm high
- Range of sizes
- White or Black 50x50mm frame
- Central foot rail 350mm above floor
- 25mm E1 White melamine tops
- Double frames available for long benches
- Lengths: 1200, 1500, 1800, 2400, 3000, 3600mm
- Depths: 600, 750, 900, 1200mm
- Many options available



MOBILE BENCH



CHUNK BAR TABLE



- Rubberwood timber grain finish frame and top
- Hand made and crafted contemporary design
- 90 x 90mm solid legs
- 90mm side apron
- Polyurethane finish
- Height: 1050mm
- Available in Light Oak or Walnut
- Also available: 1800 x 700mm **\$819** CHUDBT18

VIRGINIA BAR STOOL



NEW

How healthy is your office?

zero

EXCLUSIVE TO EMPIRE
Our Citi range uses board containing near to zero formaldehyde...Does yours?

Citi: 50/50 LOOP

Creating an architecturally-inspired work space is now easier with Empire. The new Citi range offers style, uncompromising strength and practicality.

A solid steel frame construction with support beams prevents bowing and ensures maximum stability.

The Citi range is now also available with a loop leg, adding another option to the standard square (50/50) leg offering.

CABLE MANAGEMENT AVAILABLE

Soft wiring, modular wiring or 'plug & play wiring' enables the easy use and re-use of electrical wiring components when installing or re-configuring commercial office workstations without the waste associated with hard wiring.



Citi FRAMES AVAILABLE IN BLACK OR WHITE 50/50 AND LOOP

RETURN SCREEN (Inc.Brackets)		
Size(mm)	Price	Code
750W x 480H	\$99	CTDM0575

CADDY CUSHION for Mobile Peds or Caddies
ONLY \$30 SAVE \$20
CTTOPPA

SCAN HERE TO VIEW THE CATALOGUE

SEE THE FULL RANGE IN OUR WORKSTATION SYSTEMS CATALOGUE AT empirefurniture.com.au

DESK-TOP SCREEN - STRAIGHT TOP OPTIONS

DESK-TOP SCREEN - L-SHAPE TOP OPTIONS

BACK-TO-BACK FROM

\$300

PER PERSON
CTxBB41275



DESK-TOP SCREEN

- 480mm above desk height
- 32mm slimline finish
- Mounted with sturdy steel brackets
- Finish - White powder coated aluminium frame
- Commercial fabric: 4 standard colours (other colours available SPOA)
- "Pinnable" surface

WORK TOP - finished height 720 mm + 10 mm adjustable feet

- 25mm E0 Melamine (Environmentally-friendly)
- 2 cable entry points in all desks
- Melamine colour - White (other colours available SPOA)
- 2mm impact resistant solid PVC edging
- 750mm deep in 3 lengths

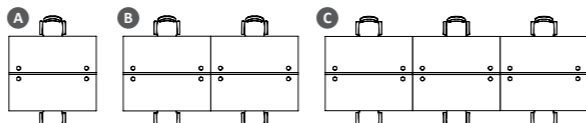

DOUBLE SIDED - STRAIGHT TOP - DESK TOP SCREEN

Top Sizes (mm)	A 2 Person Code	B 4 Person Code	C 6 Person Code
1800W x 750D	CTxBB21875	CTxBB41875	CTxBB61875
1500W x 750D	CTxBB21575	CTxBB41575	CTxBB61575
1200W x 750D	CTxBB21275	CTxBB41275	CTxBB61275

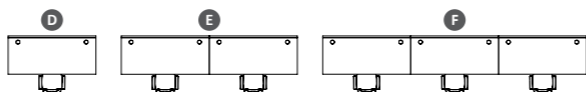

SINGLE SIDED - STRAIGHT TOP - NO SCREEN

Top Sizes (mm)	D 1 Person Code	E 2 Person Code	F 3 Person Code
1800W x 750D	CTxSS1875	CTxSS21875	CTxSS31875
1500W x 750D	CTxSS1575	CTxSS21575	CTxSS31575
1200W x 750D	CTxSS1275	CTxSS21275	CTxSS31275

SINGLE-SIDED FROM

\$265

PER PERSON
CTxSS21275

STANDARD SCREEN FABRICS



ADDITIONAL COLOURS AVAILABLE

REF.	DIMENSIONS (mm)	CODE	PRICE
G	600W x 300D	CTDMSH600	\$110
G	450W x 300D	CTDMSH450	\$110

Citi LOOP

- 1000s of configurations available for Quick Delivery

FROM \$327
PER PERSON
CLxBB41275.WHxx



ACOUSTIC SCREENS ALSO AVAILABLE

*Based on Citi LOOP / fabric panel screen / 1200 long / 4 person
• As pictured, compact laminate screen (.WHCL) \$363 pp



'X' CONFIG. - L-SHAPE - DESK TOP SCREEN	
Top Sizes(mm)	Code
1800W x 1800W x 750D	CTxLX41818S
1800W x 1500W x 750D	CTxLX41815S
1800W x 1200W x 750D	CTxLX41812
1500W x 1500W x 750D	CTxLX41515

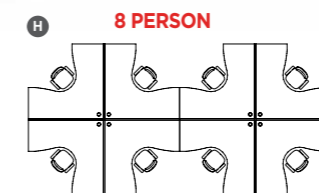

'XX' CONFIG. - L-SHAPE - DESK TOP SCREEN	
Top Sizes(mm)	Code
1800W x 1800W x 750D	CTxLX81818S
1800W x 1500W x 750D	CTxLX81815S
1800W x 1200W x 750D	CTxLX81812



'X' CONFIGURATION



FROM \$733
PER PERSON
CLxLX41818S
Loop leg

'H' CONFIGURATION

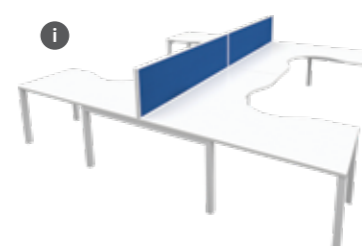

FROM \$657
PER PERSON
CTxLH41818S

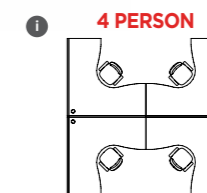

'H' CONFIG. - L-SHAPE - DESK TOP SCREEN	
Top Sizes(mm)	Code
1800W x 1800W x 750D	CTxLH41818S
1800W x 1500W x 750D	CTxLH41815S
1800W x 1200W x 750D	CTxLH41812

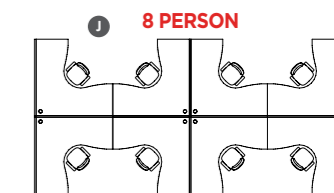

'HH' CONFIG. - L-SHAPE - DESK TOP SCREEN	
Top Sizes(mm)	Code
1800W x 1800W x 750D	CTxLH81818S
1800W x 1500W x 750D	CTxLH81815S
1800W x 1200W x 750D	CTxLH81812



SEE THE FULL RANGE IN OUR WORKSTATION SYSTEMS CATALOGUE AT empirefurniture.com.au

Citi FRAMES AVAILABLE IN BLACK OR WHITE 50/50 AND LOOP

Citi

- 50/50
- LOOP

OFFICE FURNITURE

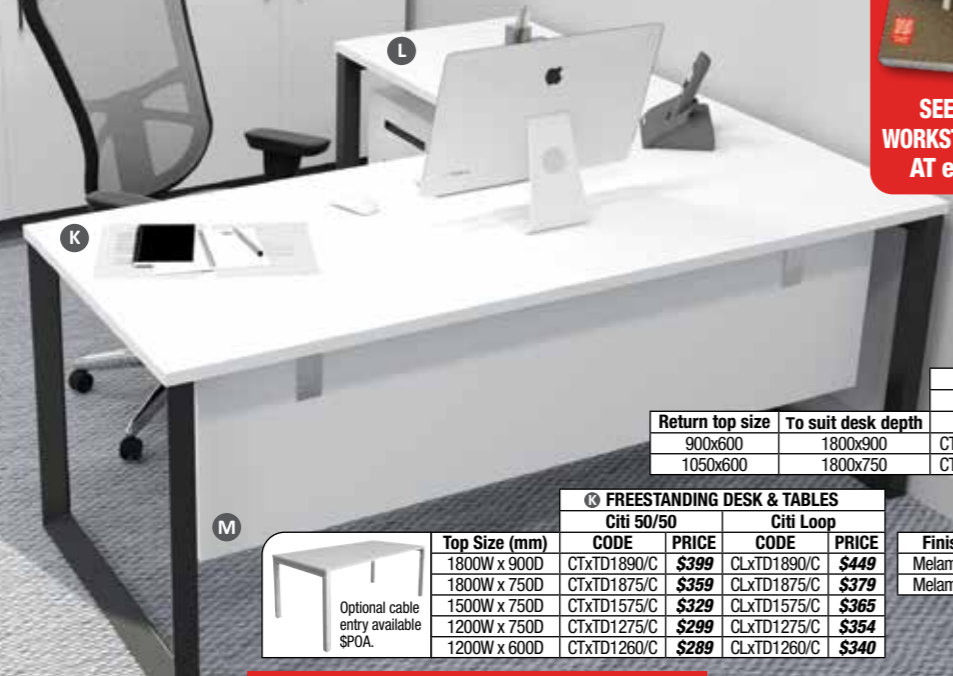

FITTED RETURN					
		Citi 50/50		Citi Loop	
Return top size	To suit desk depth	CODE	PRICE	CODE	PRICE
900x600	1800x900	CTxRT0960	\$210	CLxRT0960	\$224
1050x600	1800x750	CTxRT1060	\$210	CLxRT1060	\$224

FREESTANDING DESK & TABLES					
		Citi 50/50		Citi Loop	
Top Size (mm)	CODE	PRICE	CODE	PRICE	
1800W x 900D	CTxTD1890/C	\$399	CLxTD1890/C	\$449	
1800W x 750D	CTxTD1875/C	\$359	CLxTD1875/C	\$379	
1500W x 750D	CTxTD1575/C	\$329	CLxTD1575/C	\$365	
1200W x 750D	CTxTD1275/C	\$299	CLxTD1275/C	\$354	
1200W x 600D	CTxTD1260/C	\$289	CLxTD1260/C	\$340	

MODESTY PANELS					
Finish	To suit top	CODE	PRICE		
Melamine	1800W	MOD164	\$106		
Melamine	1500W	MOD134	\$104		

Citi STORAGE Citi desks are tested to AS/NZS 4442

How healthy is your office?

zero

EXCLUSIVE TO EMPIRE
Our Citi range uses board containing near to zero formaldehyde...Does yours?

Citi

PANEL SYSTEM

- 1200mm or 1500mm High
- 32mm slimline finish
 - Available in 2 heights, 1200mm (shown) and 1500mm & 4 widths
 - Finish – White powder coated aluminium frame
 - Commercial fabric “Charcoal” (other colours available SPOA)
 - White Melamine below desk top
 - “Pinnable” Surface



Citi PANEL SYSTEMS

RECENT Citi INSTALL

CALL CENTRE PODS FROM **\$424** PER PERSON CTPDBB61275

POP-IN POWER & USB \$129 SOFT80

Citi WORKSTATION

SHOWN WITH BLACK FRAME

		Citi 50/50		Citi Loop	
DIMENSIONS (mm)	CODE	PRICE	CODE	PRICE	
1500 x 1500 x 750	CTxWS1515	\$549	CLxWS1515	\$614	
1800 x 1200 x 750	CTxWS1812	\$569	CLxWS1812	\$597	
1800 x 1500 x 750	CTxWS1815S	\$579	CLxWS1815S	\$639	
1800 x 1800 x 750	CTxWS1818S	\$589	CLxWS1818S	\$649	

Citi HORIZONTAL CUPBOARD **Citi HORIZONTAL BOOKCASE**

ONLY \$657 CTSC0918

ONLY \$459 CTBC0918

• 900H x 1800W x 400D

Citi BOOKCASE & CUPBOARD

		NO DOORS		WITH DOORS		
DIMENSIONS (900Wx400D)		NO	DOORS	WITH	DOORS	
1800mm High	N1	CTBC18	\$329	O1	CTSC18	\$479
1200mm High	N2	CTBC12	\$239	O2	CTSC12	\$359
900mm High	N3	CTBC09	\$189	O3	CTSC09	\$288

Citi MOBILE CADDY

• 579H x 994W x 520D

• 4 options for either left or right, or both.

• Mix and match configurations

CODE	PRICE	REF.
CTMCSHSH	\$229	S1 + S1
CTMCSHDF	\$378	S1 + S2
CTMCSHTD	\$519	S1 + S4

SHELF S1, DRAWER & FILE S2, 3 DRAWERS S3, TAMBOUR S4

CADDY CUSHION for Mobile Peds or Caddies ONLY \$30 CTTOPPA

Citi HALF DOOR BOOKCASE

DIMENSIONS (mm)	CODE	PRICE	REF.
1800H x 900W x 400D	CTSC18HD	\$439	P

Citi MOBILE CADDY

'U' CONFIGURATION

'T' CONFIGURATION

FROM **\$782** PER PERSON CTxPLT21818S

'T' CONFIG. - L-SHAPE TOP PANEL SCREEN (1200H)	
Top Size (mm)	Code
1800W x 1800W x 750D	CTxPLT21818S
1800W x 1500W x 750D	CTxPLT21815S
1800W x 1200W x 750D	CTxPLT21812
1500W x 1500W x 750D	CTxPLT21515

'H' CONFIG. - L-SHAPE TOP PANEL SCREEN (1200H)

Top Size (mm)	Code
1800W x 1800W x 750D	CTxPLH41818S
1800W x 1500W x 750D	CTxPLH41815S
1800W x 1200W x 750D	CTxPLH41812

'X' CONFIG. - L-SHAPE TOP PANEL SCREEN (1200H)	
Top Size (mm)	Code
1800W x 1800W x 750D	CTxPLX41818S
1800W x 1500W x 750D	CTxPLX41815S
1800W x 1200W x 750D	CTxPLX41812
1500W x 1500W x 750D	CTxPLX41515

SCREEN PANELS

FROM **\$937** PER PERSON CTxPLU21818S

2 PERSON

WORKTOPS - STRAIGHT

WORKTOPS - L-SHAPE

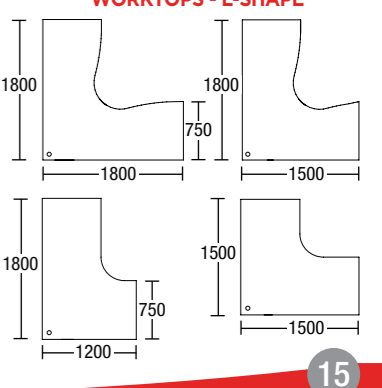
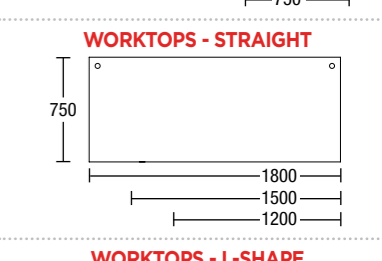
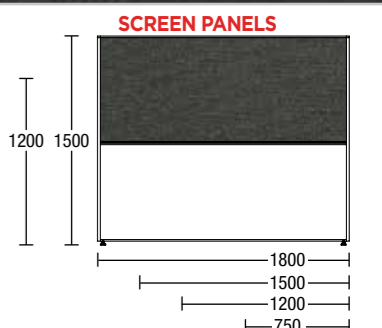

**Citi FRAMES
AVAILABLE IN
BLACK OR WHITE
50/50 AND LOOP**

**Citi
120°
PANEL SYSTEM**

FROM
\$463
PER PERSON
CTxP12091212

CITI ADDITIONAL PRODUCTS

Citi DESK HUNG SCREEN

- Fabric available in Citi Charcoal only
- Includes 2 end trims
- Includes mounting brackets
- Other colours POA

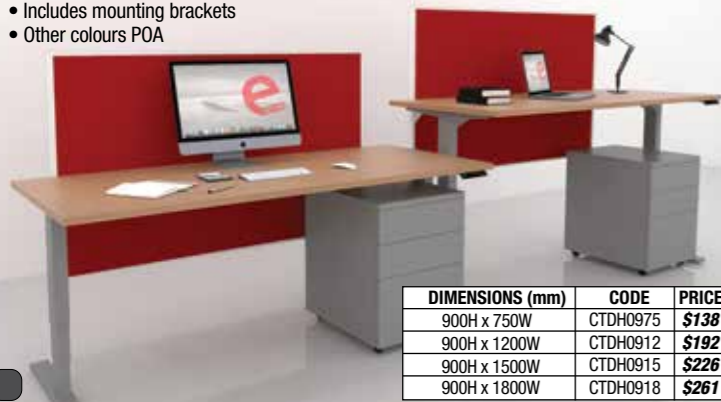

DIMENSIONS (mm)	CODE	PRICE
900H x 750W	CTDH0975	\$138
900H x 1200W	CTDH0912	\$192
900H x 1500W	CTDH0915	\$226
900H x 1800W	CTDH0918	\$261

Citi CLAMP ON SCREEN



- Easy attachment
- Suits most standard desks



DIMENSIONS (mm)	CODE	PRICE
480H x 1200W	CTDC0512	\$173
480H x 1500W	CTDC0515	\$198
480H x 1800W	CTDC0518	\$219

STANDARD CPU HOLDER FIXED ARM \$69 LXAC104

- Extension slide adjusts to suit width of PC
- MAX PC: 180mmW x 410mmH
- MIN PC: 80mmW x 210mmH
- Silver or White



DELUXE CPU HOLDER SPRING - SLIDE / SWIVEL \$89 LXAC104S

- Twist & Slide
- MAX PC: 120mmW x 380mmH
- MIN PC: 90mmW x 280mmH
- Silver or White highlights



CPU HOLDERS & LCD MONITOR ARMS

Citi CPU HOLDER \$55 CCAC09.WH



- Lockable castors
- Max PC: 210mm W

Citi MONITOR SINGLE ARM



\$119
SAVE \$30
CTARM01

- 442mm arm reach
- Height adjustment 400mm height range
- 80° up/down tilt
- 90° left/right pan
- Quick release for easy screen removal
- 75mm or 100mm VESA compatible
- Weight Capacity 15kg per arm
- Colours: Silver, White or Black

Citi MONITOR DOUBLE ARM



\$209
SAVE \$40
CTARM02

Citi MONITOR SINGLE + LAPTOP



\$259
SAVE \$40
CTARM01L

SWISH STRAIGHT RECEPTION COUNTER

CTSC0918 - 1800L x 900H
Citi Storage Cupboard
(With 4 Doors \$657)



empire
5
YEAR
WARRANTY
ONLY
\$899
SWRD1875

1800W x 750D x 1160H

**GREET YOUR CLIENTS
IN STYLE!**

- White with coloured feature panels
- Work surface 750mm deep (Return 600mm deep)
- Feature panel colours - select Charcoal or Brushed Silver

SWISH L SHAPE RECEPTION COUNTER



empire
5
YEAR
WARRANTY
ONLY
\$1459
SWRC1816

1850W x 1700D x 1160H
Left or right return



empire
5
YEAR
WARRANTY

MOSMAN 1800



- 1800W x 950D x 1150H
- 2-Pac finish
- Worktop in Teak or White finish
- Jade White Caesar Stone hob
- Aluminum kick plate



- 2500mm also available (includes Front feature panel)

DRIFTWOOD RECEPTION COUNTER



NEW • 2200 W x 800D x 1150H

empire
5
YEAR
WARRANTY
ONLY
\$1279
DRIFT01.BW

- Worktop 730H
- Driftwood Wrap Around Cowl With Feature Panel
- Adjustable Feet For Levelling
- Built in 3 Drawer Underdesk Pedestal + Built In CPU & Storage Cupboard
- 2 x Chrome Metal Cable Entry Covers With Brush Insulator

BREATHE WITH MODESTY PANELS



- Scallop for cable access
- 750mm deep top for more workspace
- Hidden cable tidy in legs

- Sturdy powdercoated frame and legs
- Comes with metal perforated modesty panel
- Range of sizes to choose from to suit your space
- E0 Melamine top
- 730H

LEGS
TOPS
FROM
\$289
BRDK1275

STRAIGHT DESKS		
DIMENSIONS (MM)	CODE	PRICE
1200 x 750	BRDK1275	\$289
1500 x 750	BRDK1575	\$309
1800 x 750	BRDK1875	\$339



CORNER WORKSTATIONS		
DIMENSIONS (MM)	CODE	PRICE
1500 x 1500	BRWS151575	\$489
1800 x 1200	BRWS181275	\$469
1800 x 1500	BRWS181575	\$519
1800 x 1800	BRWS181875	\$529

empire
5
YEAR
WARRANTY

SPARK BOARDROOM TABLES



MANY Colours available POA



- 3 leg colour options: Chrome, Black & White
- 25mm E0 melamine top (Boat-shape)
- Solid steel sub-structure
- 2mm impact resistant PVC edging
- Custom sizes and colours available



MILANO RANGE

Milano Leg (Aluminium)
Available in 3 Colours

MILANO ROUND TABLE		
Size	Price	Code
1000 Diameter - 3 Legs	\$519	MLMT10
1200 Diameter - 4 Legs	\$669	MLMT12

MILANO BOARDROOM TABLE (boat-shaped)		
Size	Price	Code
2400 x 1200 - 4 Leg	\$859	MLBT2412B
3000 x 1200 - 6 Leg	\$1239	MLBT3012B

- Polished aluminium leg & beam construction
- Custom built tables made to your specifications
- Top options (POA) - Sharknose Edge, Flat Edge, 13mm Compact Laminate
- Also available with an in-table power/data box. \$POA
- Many sizes available



COMPLETE THE LOOK CORPORATE ARTWORK



- FROM \$109 ART00x118
- 3 sizes: 1800 x 1180mm, 1350 x 900mm, 1180 x 800mm
 - 4 frames: black, white, natural or none
 - High quality canvas art

SIMULATED TREES

FROM \$59 TREExx

- Many styles and sizes

Spark Meeting & Boardroom Tables					
Style	Legs	Size	Code	Black/White Leg	Chrome Leg
Meeting Table	4	1000 Diam	SPMT1000	\$449	\$507
Meeting Table	4	1200 Diam	SPMT1200	\$489	\$547
Boat Shape	4	2400x1200	SPBT2412B	\$728	\$786
Boat Shape	4	3000x1200	SPBT30122B	\$811	\$869
Boat Shape	6	3000x1200	SPBT30123B	\$1041	\$1128



DESKS FROM \$755 1800 Flat Edge

A STRAIGHT DESK	25mm FLAT EDGE SHARKNOSE	B MODESTY PANEL SUITS 1800MM LONG DESK
1800W x 900D x 725H MLDK1890	\$755	Melamine (as pictured) MOD164.xx \$99
2100W x 900D x 725H MLDK2190	\$787	Perforated metal B2MOD1515 \$55

FITTED RETURN - 1200W (not pictured)	25mm FLAT EDGE SHARKNOSE
Full Height Pedestal Return - MLRTP1260 2 Drawer + File / 4 Drawer / 2 File Drawers 700D x 725H - MLRT1270	\$379 \$419
Open Return - With Milano Leg	\$389 \$439

- Polished aluminium leg and beam constructions
- Available in 25mm melamine with Straight Edge or Sharknose Edge
- Squareline Brushed Silver handles
- Levelling adjustment in feet • 22 colours available
- Many customised sizes and combinations available

Boardroom Tables

PH: 1300 400 521
empirefurniture.com.au

LUNA ROUND TABLES

FROM \$239 1000 TOP LUNA10

Top Diameter	Base Options		
	Brass or Copper	Black or White	Stainless
1000 LUNA10	\$289	\$239	\$259
1200 LUNA12	\$449	\$349	\$389

FROM \$349 1200 TOP LUNA12

Stainless base

WHITE BASE ALSO AVAILABLE

BRASS BASE ALSO AVAILABLE

Copper base

1000mm top with 540mm base

1200mm top with 720mm base

Tops: .WH, .RC, .SB

LUNA COFFEE TABLES

430mm High

600mm diameter top in Cherry, Beech or White

i Brass	ii Copper	iii Stainless	Black	White
\$179	\$179	\$159	\$159	\$159

MANY Colours available POA

HARMONY DESIGNER BOARDROOM TABLES



Harmony Boardroom Tables	Boat-Shape - Select Beech, Red Cherry or White
2400 x 1200 (2 Leg)	\$639 HARM2412B.xx
3000 x 1200 (3 Leg)	\$889 HARM3012B.xx

- Available in Boat Shaped, Rectangular and D-End
- Attractive designer frame with Chrome and Silver highlights
- Matching desk and return are also available
- Available in Red Cherry, Select Beech, or White
- Other colours available \$POA

Innova Boardroom Tables

Exquisite Design Exceptional Quality

- Sharknose E-Zero "Oak" MDF Tops / Charcoal sides
- Polished Alloy Legs
- Integrated "Flip-Box" Cable Management Access (soft-wiring not included)

Item	Code	Details	Now	Save
A	INNMT900	Innova Round Table 900mm	\$383	\$486
B	INNBT3012	Innova Boardroom Table 3000 X 1200mm	\$925	\$774
C	INNBT3815 (as pictured)	Innova Boardroom Table 3800 X 1500mm	SOLD OUT!	



UP TO 55% OFF*

*While stocks last

1 **ROUND** 2 **CRESCENT** 3 **ARC** 4 **RECTANGLE**



 FROM \$236 ACTROUND WHITEBOARD TOP NOW AVAILABLE	 FROM \$242 ACTCRESC WHITEBOARD TOP NOW AVAILABLE	 FROM \$274 ACTARC WHITEBOARD TOP NOW AVAILABLE	 FROM \$271 ACT1575 WHITEBOARD TOP NOW AVAILABLE
---	---	---	--



IDEAL FOR EDUCATIONAL USE

Top Shape	Code	Price	Code	Price
1a Round	ACTROUND	\$236	ACTROUND.AW	\$320
1b Round WB*	ACTROUND.WB	\$274	ACTROUND.AW.WB	\$358
7a Crescent	ACTCRESC	\$242	ACTCRESC.AW	\$326
7b Crescent WB*	ACTCRESC.WB	\$280	ACTCRESC.AW.WB	\$364
8a Arc	ACTARC	\$274	ACTARC.AW	\$358
8b Arc WB*	ACTARC.WB	\$313	ACTARC.AW.WB	\$397
11a Rectangle	ACT1575	\$271	ACT1575.AW	\$355
11b Rectangle WB*	ACT1575.WB	\$291	ACT1575.AW.WB	\$375

All Acer tops are 18mm thick MDF *Whiteboard tops have 12 month warranty

COMPARE OUR TOP SIZES

Acer tables offer lower "cost per student"... Acer 1200mm diameter tables accommodate 4 students, other 900mm diameter tables accommodate 1 student.



Available Table Frames: (Check specific products to see which frames apply)

F Fixed Height Leg (with levelling feet) 720mm high	W Fixed Height Leg (with lockable castors) 720mm high	AW Height Adjustable Leg (with lockable castors) 6 heights: 550 610 640 680 720 750mm	B Bench Height Leg (with levelling feet) 900mm high	BW Bench Height Leg (with lockable castors) 970mm high	FP Flip Table (with lockable castors) 720mm high
---	---	---	---	--	--

The only flip frame suitable for 1200mm tops
 Strong 60mm height adjustable leg
 Heavy duty lockable castors on all legs

empire 7 YEAR WARRANTY
 e zero
 ADVANCED TESTED & CERTIFIED

GROW DESK - 9 HEIGHT POSITIONS

NO TOTE 600 X 450 \$115 (SAVE \$14 GRDKC0604/T)
NO TOTE 600 X 600 \$135 (SAVE \$14 GRDKC0606/T)

• Optional - Tote/rail \$20

• Curved cross-rail provides more leg room on 450mm deep model
 • 1200mm wide
 • Grow tote with rails (pack of 2) Suits Grow 1200W desk \$65

NO TOTE 1200 X 600 \$189 (GRDKC1206/T)

Top	Size mm	Code	Price
Single	600W x 450D	GRDKC0604/T	\$115
Single	600W x 600D	GRDKC0606/T	\$135
Double	1200W x 600D	GRDKC1206/T	\$189

• All new design
 • Tested and Certified to the Australian Standard
 • Height adjustable - 9 positions
 • Height range 550 - 750mm
 • Academy and Plato desks feature an 18mm environmentally friendly E-Zero top with tamper-proof, moulded PP edging and a strong steel frame

empire 7 YEAR WARRANTY e zero ADVANCED TESTED & CERTIFIED

FOLD UP EXAM TABLE

730 HIGH \$119 (FOLDUPTABLE)

• H730 x W800 x D550mm
 • 18mm E-Zero top
 • Folding frame

Assembly Included e zero empire 7 YEAR WARRANTY

PLATO STOOL

2 HEIGHTS \$89 (PLSTxx)

• Heights: 370mm or 450mm
 • Diameter 330mm
 • Base encourages movement

CATO STOOLS

STOOL \$85 (CATO650)

• Charcoal only
 • Seat height: 650mm
 • Splayed legs to minimise potential for tipping
 • Stack 7 high

Also avail. with Ply seat \$129 CATO650.OKT

empire 7 YEAR WARRANTY ADVANCED TESTED & CERTIFIED

WITH BACK \$95

\$95 (CATO650B)

PODZ CUBEE

ONLY \$169 (PDCUBEC)

• 450mm wide

PODZ GEO

ONLY \$359 (PDGEOC)

• 1300mm wide

PODZ RONDO

ONLY \$179 (PDRONDC)

• 480mm diameter
 • Ball-bearing castors with rubber wheels
 • All ottomans 460mm high

PODZ CENTRIC

ONLY \$489 (PDCENTC)

• 1120mm wide

PODZ FLOWER PACKAGE

5 PETALS & CENTRE
 MIX & MATCH COLOURS
 • 1280mm x 1230mm

THE LOT \$1179 (PDFLOWER)

empire 5 YEAR WARRANTY e zero ADVANCED TESTED & CERTIFIED

PODZ LILYPAD PACKAGE

\$60 ea (PDLPCENT)

EXTRA LARGE 610mm Dia. 90mm thick
 Trolley \$159 PDLPTROLLEY
 • 1120mm high
 • Holds 11

PLATO CHAIR

Tested to AS/NZS 4610.2 Education Chairs. 180kg Static Load Test. 200,000 Seat/Back Fatigue Test.
 • High Impact Polypropylene 1 piece frame
 • Back leg angle designed to discourage backward rocking

Grade	Seat Height	Code	Suits Desk Ht.	Price
Kindy/Prep	300	PLCH300	495	\$29
1-2	335	PLCH335	550	\$34
3-5	355	PLCH355	610-660	\$35
6-7	400	PLCH400	660	\$38
8-12	460	PLCH460/L	720	\$44
With seat pad	460	PLCH460LU	720	\$79

460 HIGH \$44 (PLCH460L)

Stackable - 10 High

New colour Pacific Blue

empire 7 YEAR WARRANTY e zero ADVANCED TESTED & CERTIFIED



NEW RELEASE PLATO LINK



The ever popular Plato chair (460mm) is now also available with easy linking feature ideal for school halls, assembly areas, canteens etc.
 • Also available chair trolley for easy move and reset (TROLCH01-04) \$POA

Optional seat pad PLCH460LU

empire 7 YEAR WARRANTY e zero ADVANCED TESTED & CERTIFIED

MOBILE WHITEBOARDS



- \$269** SAVE \$30
1200W x 1000H
TSMWB1210
- \$329** SAVE \$10
1500W x 1000H
TSMWB1510
- \$349** SAVE \$20
1800W x 1000H
TSMWB1810

• Double sided • Sturdy frame • 1750mm overall height

HEIGHT ADJUSTABLE SANITISER STAND WITH AUTOMATIC 'NO TOUCH' DISPENSER



- \$239** ONLY SAVE \$70
HAND01
 - \$109** ONLY SAVE \$20
HAND02
- ALSO AVAILABLE WALL MOUNT SANITISER STATION
- Non-tilt floor standing
 - 4 x AA Battery operated (not included)
 - Adjustable flow control: 0.3ml / 0.4ml / 0.5ml
 - Perfect for all public space entry ways
 - Sanitising gel not included
 - 1 Year warranty

SATELLITE TEACHERS CADDY



- \$549** ONLY SAVE \$158
SATE04.SV
 - \$759** ONLY SAVE \$158
SATE04TS.LT
 - \$499** ONLY SAVE \$158
SATE02T0.LT
- Size: 485W x 500D x 1070Hmm
 - Top size: 485W x 500D
 - With Slide out Worktop
 - Routed Handles
 - Gang Lock (all locking drawers)
 - Heavy Duty Locking Castors
 - 2 Standard Drawer + 2 x File Drawers
 - Silver "E0" Board with Black Edge or Oak

FUSION LEARNING CENTRE



- \$569** ONLY SAVE \$158
FUSIONSTD
- Strong paper holder
 - Heavy duty locking castors
 - Includes rear storage
 - Includes magnetic whiteboard
 - 830W x 450D x 1560H
 - * Tote boxes extra \$13ea TOTE120

BLOK SCREENS



- \$269** FROM
- 1500H x 1500W \$269 BLOK1515
 - 1500H x 1800W \$319 BLOK1518
 - 1800H x 1500W \$319 BLOK1815
 - 1800H x 1800W \$329 BLOK1818
 - 50mm thick • Pinnable surface

MAGNETIC DESIGNER GLASS BOARD



- \$239** FROM
- Lifetime stain free surface
 - 4mm safety toughened glass
 - 8 times stronger than glass
 - 500mm glass pen shelf
 - 5 super magnets supplied

NOW AVAILABLE IN BLACK BACKED SURFACE

1200W x 600H	\$389	TRMG1206B
1800W x 1200H	\$939	TRMG1812B

900W x 600H	\$239	TRMG0906
1200W x 600H	\$369	TRMG1206
1200W x 900H	\$509	TRMG1209
1500W x 900H	\$629	TRMG1509
1500W x 1200H	\$739	TRMG1512
1800W x 1200H	\$839	TRMG1812
2100W x 1200H	\$959	TRMG2112
2400W x 1200H	\$1089	TRMG2412

COMMUNICATE ROOM DIVIDER



- \$549** ONLY SAVE \$120
COMD02

- 900W x 1800H
- Each Divider can be linked together with the Connector Kit COMD01 \$29
- Side 1 - magnetic whiteboard with magnetic pen shelf and adjustable flipchart pad hooks
- Side 2 - pinnable charcoal fabric
- 90mm locking castors

IDEAL FOR MAKER SPACE - 1800 X 1200



- \$907** ONLY SAVE \$120
SRBE1812T15
- ### STEAMROLLER WITH 15 TOTES
- Fixed height 1040mm
 - Writable whiteboard surface
- Includes:
- Stores 15 totes
 - Does not include tote trays
 - Optional totes add \$210

NEW-MATIC LECTERN



- \$459** ONLY SAVE \$158
NMTA650
- GAS LIFT!**
- New design with easy lift capacity
 - Table top section is 650 x 400mm
 - Height adjustable from 750-1120mm
 - Powder coated satin white steel stand with 40mm lockable castors

BREAKROOM TABLE



- \$469** ONLY SAVE \$158
NMMT800
- GAS LIFT!**
- Unique patented Pneumatic Air lift mechanism
 - Table top 800mm in 18mm white melamine
 - Height adjustable from 688-1058mm
 - 40mm lockable castors with powder coated ivory steel stand

STAX EXAM TABLE



- \$139** ONLY SAVE \$158
STAXTABLEB
- Stax Trolley STAXTROLLEY \$300**
- H720 x W750 x D700mm
 - 12mm MDF Top (E1) with heavy duty slimline rod frame
 - Available in Diamonds top with Pearl Silver powdercoat frame or Oak top with black frame
 - Stackable up to 25 high on a trolley

Citi FREE STANDING PANEL SCREEN

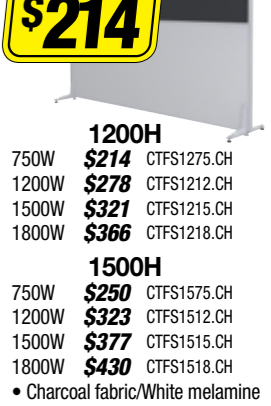

- \$214** FROM
- 1200H \$214 CTF51275.CH
 - 1200W \$278 CTF51212.CH
 - 1500W \$321 CTF51215.CH
 - 1800W \$366 CTF51218.CH
 - 1500H \$250 CTF51575.CH
 - 1200W \$323 CTF51512.CH
 - 1500W \$377 CTF51515.CH
 - 1800W \$430 CTF51518.CH
 - Charcoal fabric/White melamine

FELT PINBOARDS

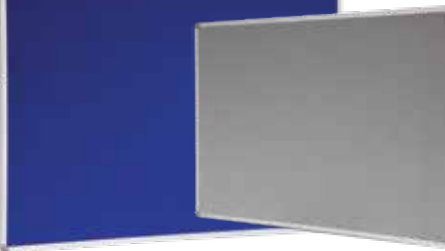

- | | | |
|---------------|-------|----------|
| 900W x 600H | \$69 | TSPB0906 |
| 1200W x 900H | \$99 | TSPB1209 |
| 1500W x 900H | \$149 | TSPB1509 |
| 1800W x 900H | \$159 | TSPB1809 |
| 2400W x 1200H | \$269 | TSPB2412 |
- Strong extra thick felt
 - Wall fixings supplied
 - Available in Blue or Grey

WALL MOUNT WHITEBOARD



- | | | |
|---------------|-------|----------|
| 900W x 600H | \$69 | TSWB0906 |
| 1200W x 900H | \$119 | TSWB1209 |
| 1500W x 900H | \$139 | TSWB1509 |
| 1800W x 900H | \$179 | TSWB1809 |
| 1800W x 1200H | \$229 | TSWB1812 |
| 2400W x 1200H | \$269 | TSWB2412 |
| 3000W x 1200H | \$369 | TSWB3012 |
- No pen residue
 - Solid aluminium frame
 - Concealed wall fixings

WASTE PAPER BIN



- \$22** ONLY SAVE \$158
TECH08
- Steel mesh
 - 295 diameter

SPACEMASTER WRITING PLATFORM



- \$139** ONLY SAVE \$158
SPACS60
- 560W x 310D
 - Ergonomic writing platform
 - Height adjustable
 - Includes non slip writing guide
 - Two writing lips of different heights
- INCREASE DESK SPACE & RELAX WORKING POSTURE**
- Easy height adjustment

STOREWELL TOTE TROLLEY

10 TOTE - DOUBLE 820W X 460D X 920H
 15 TOTE - TRIPLE 1250W X 460D X 920H



- \$439** ONLY SAVE \$158
STCTOTR10/TOTES
 - \$619** ONLY SAVE \$158
STCTOTR15/TOTES
- PRICES INCLUDE TOTES
- Heavy duty locking castors
 - E-Zero MDF carcass (Silver or Oak)
 - Packages include tote boxes
 - Mix and match Classic or Maxi totes
- | | | | | | |
|-------------|----------------|--------------|---------------------|------------------|--------------|
| White (.WH) | Charcoal (.CH) | Orange (.OR) | Light Green (.GNLT) | Cranberry (.CRA) | Purple (.PU) |
|-------------|----------------|--------------|---------------------|------------------|--------------|
- | |
|---|
| CLASSIC TOTES
420W x 365D x 120H
TOTE120.xx |
| MAXI TOTES
420W x 365D x 270H
TOTE220.xx |



SEE THE FULL RANGE IN OUR NEW EDUCATION BROCHURES AT empirefurniture.com.au

SCAN HERE TO VIEW THE CATALOGUE

"XO" DELUXE LECTERN & MOBILE RESOURCE CENTRE



- \$239** ONLY SAVE \$205
XOLECT01
 - \$299** SMALL ONLY SAVE \$34
XORESC01
- WHILE STOCK LASTS**
- Fixed height
 - 590W x 510D x 1145H
 - White matte steel base
 - 5cm high barrier strip on desktop
 - Steel handle
 - 598W x 450D x 1000H
 - Lockable single drawer and door

4 LEG TABLES

TIMMY STEEL-FRAME TABLES & BENCHES

CHOOSE THE SIZE THAT SUITS YOUR NEEDS! BEST PRICES!



ALSO AVAILABLE
 "Tested and Certified" model
Emmy steel frame table
 EMSFXXX \$POA

Size	A 4 Leg (Black) (735mm H)	B Benches (1,025mm H)	C Folding (Silver) (735mm H)
1200x600	\$199 TISF1260.xx	\$249 TISFH1260.xx	—
1500x750	\$239 TISF1575.xx	\$326 TISFH1575.xx	\$299 SHFT1575.xx
1800x750	\$255 TISF1875.xx	\$341 TISFH1875.xx	\$319 SHFT1875.xx
1800x900	\$285 TISF1890.xx	—	\$339 SHFT1890.xx

BENCHES

FOLDING TABLES

QUICK SHIP COLOURS

- Priced in Select Beech, Red Cherry or White Tops
- Many sizes & colours available \$POA
- 40mm sturdy steel tube with 25mm Top
- Adjustable feet

TIMMY TABLES - 19 colours & many sizes available \$POA

1. 600 x 600	6. 1200 x 600	11. 1500 x 750	16. 1800 x 900
2. 600 x 750	7. 1200 x 750	12. 1500 x 900	17. 1800 x 1200
3. 900 x 600	8. 1200 x 900	13. 1500 x 1200	18. 2100 x 600
4. 900 x 750	9. 1200 x 1200	14. 1800 x 600	19. 2100 x 750
5. 900 x 900	10. 1500 x 600	15. 1800 x 750	20. 2100 x 900
LENGTHS: 600/900/1200/1500/1800/2100MM		21. 2100 x 1200	
WIDTHS: 600/750/900/1200MM		HEIGHTS: 735/1025MM	

SUNRISE MODULAR LOUNGE SYSTEM

- Many layout configurations available
- Stocked in new commercial grade fabric (Charcoal)
- Booth panels upholstered in designer quilted fabric



ASK ABOUT OUR SUPERCEDED STOCK UP TO 60% OFF*



Seat	No Arms - 760H x 750D			With Arms - 760H x 750D			Bench - 420H x 750D			Booth - 1400H x 750D		
	Length mm	Code	Price	Length mm	Code	Price	Length mm	Code	Price	Length mm	Code	Price
1	650	SRISE01L	\$439	890	SRISE01LA	\$709	650	SRISE01B	\$309	710	SRISE01LB	\$1249
2	1300	SRISE02L	\$939	1540	SRISE02LA	\$1209	1300	SRISE02B	\$679	1360	SRISE02LB	\$2019
3	1950	SRISE03L	\$1269	2190	SRISE03LA	\$1539	1950	SRISE03B	\$879	2010	SRISE03LB	\$2619

Low-line Coffee Table 640W x 640D x 270Hmm SRISCT0606 **\$149**
 Dual USB Port Add **\$40** per port

ECHO FLIP TABLE

FROM \$349
 ECH1575

NEW low height (650mm) Ideal for Primary!
 ECHxxxxL

Top Size	Top	Code	Price
1500 x 750mm	A	ECH1575	\$369
1500 x 750mm	B	ECH1575	\$399
1500 x 750mm (WB)	C	ECH1575	\$429
1800 x 750mm	A	ECH1875	\$389

• Adjustable length beam
 *Some colours avail. 1500 x 750 only

RACER/ACER FLIP TABLE

FROM \$466
 ACER 1200mm Dia. ACFPROUND

WHITEBOARD TOPS NOW AVAILABLE 1200MM DIA. ONLY \$504 ACFPROUNDWB

Top Size	Code	Price
1000 Diam	RRFP1000D	\$489
1200 Diam	RRFP1200D	\$529

• Height ranges: 675/715/745mm
 • Top size (mm): 600W x 500D

DYNAMIC FLIP TABLE

ONLY \$281
 DYTFLIPP0D

• Height Adjustable
 • Mobile
 • Silver or Parchment top only

QUADRIC TABLES

Tables - 720mm High				
Table Size mm	Code	18mm	25mm	Whiteboard
600W x 600D	QDTB0606	\$114*	-	\$114*
700W x 550D	QDTB0705	\$123*	-	\$129*
1200W x 600D	QDTB1206	\$174*	\$194*	\$161
1500W x 750D	QDTB1507	\$236*	\$236*	\$236

Benches - 890mm High			
Table Size mm	Code	18mm	25mm
1200W x 600D	QDBE1206	\$212*	\$232*
1800W x 900D	QDBE1809	-	\$338*

FROM \$114
 QDTB0606

• 25mm steel frame (Black Ripple)
 *Stardust top (only 600 & 1200 include Grow moulded edge)
 *Beech, Cherry & White top
 *Acer Blue or Silver
 *Indent item

SIDE TABLES

A PEBBLE
 • 400/350W x 400D x 650H
 • Solid Steel Design with Heavy Base for Stability
 • Available in Black or White

NEW \$189
 SAVE \$10
 PEBB400

B "XO" SIDE
 • 400mm diameter White lacquer top
 • 640mm high, polished Aluminum base

\$189
 SAVE \$10
 XOST400

BENCHMARK LOUNGE SYSTEM

ASK ABOUT OUR SUPERCEDED STOCK UP TO 60% OFF*

*While stocks last

Seat	Type	Height mm	Depth mm	Length mm	Code	Price
1	Bench	420	775	760	BMARK01B	\$339
1	Lounge	715	775	760	BMARK01L	\$439
2	Lounge	715	775	1350	BMARK02L	\$639
3	Lounge	715	775	2060	BMARK03L	\$839

Vinyl Colours
 Black, Mushroom, Dark Brown, Beige, Cappuccino, Light Brown

x01B, x01L, x02B, x02L, x03B, x03L, x180B, x135LCC, x135LCV, x135B, x90LCV, x90LCC, x90B, x180LCV

• EightBy4 Series



Create your space with Konfurb

Inspired by the best of international design, Konfurb brings style, quality, ergonomics and sustainability into a comprehensive range of commercial seating for a wide variety of applications.

SEE THE FULL RANGE
IN OUR 40 PAGE
2020 KONFURB
CATALOGUE AT
empirefurniture.com.au



• Stem Series



• Star Series



ZIP

Moto Zip work pods provide a high level of acoustic and visual privacy, allowing workers to complete focused individual tasks in a comfortable environment.

10%

THE BETTER WAY TO A BETTER WORKPLACE

Moto is about providing the workplace with a family of products to better suit the diverse range of tasks that workers of today are facing. It's about empowering employees to choose a space that will work for them.

Throughout a normal working day a number of diverse tasks are undertaken. Tasks range from High to Low Focus and from Individual to Collaborative. Our furniture provides workers with a range of effective environments to match each unique task.

MOTO FELT

Available in 10 colours our Moto Felt is designed for heavy commercial use (100,000+ martindale rubs) and provides excellent sound absorption.



Ash Grey Stone Grey Charcoal Grey Deep Blue Ice Blue



Emerald Green Bumblebee Yellow Avocado Green Sunset Orange Chilli Red

SURFACES

Moto worktops are available in two different finishes, lacquered white and solid beech timber and are finished with a smooth shark nose edge.



White Lacquer Solid Beech

CATALOGUE

See the full range in our Moto ABW catalogue at empirefurniture.com.au or scan the QR code.



ARC

Moto Arc provides space for people to collaborate together, and comes with the option of additional privacy walls to enclose the space and provide a high level of privacy for workers.



MEETING

Moto Meeting is a four seater booth which provides a high level of privacy for users. This enclosed setting is ideal for anything from focused brainstorming sessions to client meet and greets.



EXPO

Moto Expo is ideal for workplace presentations, providing two defined tiers for workers to gather around. The walls provide some acoustic privacy and help to define the area for its use. The bar leaner height desks provide space for laptops or notebooks as required.

 <p>34% OFF</p> <p>Hady \$669 in Ash</p>	 <p>24% OFF</p> <p>Vienna \$599 in Ash</p>	 <p>34% OFF</p> <p>Searl \$599 in Ash</p>	 <p>42% OFF</p> <p>Neo \$669 in Ash</p>	 <p>10% OFF</p> <p>Link Laptop Table \$299 340W x 470D x 648H</p>
---	--	---	--	--

MANY Colours available POA
*Warwick Key Largo Ash fabric

PEEKABOO STOOL



Stone Green Raspberry Red Navy Blue Dodger Blue

The Peekaboo is perfect for a wide variety of uses. It features a seamless design to add strength and stability, while being lightweight, which means it is easy to stack and easy to move.

- Size: 400W x 410D x 467Hmm
- IF Design Award winner 2020

- Solid and lightweight design
- 12 stackable
- Open backrest for easy handling
- Suitable for both indoor and outdoor use*



ONLY
\$65
SAVE \$20
PEEK01



Break Out Zone

Reception Seating

The Mixx Range
 Australia's most versatile range of high quality break out visitor seating

MIXX 'N' MATCH

12 VIBRANT COLOURS TO CHOOSE FROM

- Plastic shell only

QR code: SCAN HERE TO VIEW THE CATALOGUE

SEE THE FULL RANGE IN OUR MIXX CATALOGUE AT empirefurniture.com.au

RAINBOW SOFT-SEATING SYSTEM

MODULAR & MOBILE

• Smart design - 4 simple pieces
 • Solid ply construction
 • Heavy duty locking castors
 • Easily reconfigured
 • Priced in Warwick vinyl (Lustrell Charisma) or Category 1 fabric
 • 100s of fabric options \$POA
 • Seat height 450mm | back height 750mm

Shape	Code	Size	Price
1 - Straight no back	RAIN1SNB	1872W x 450D	\$629
2 - Straight with back	RAIN2SWB	1872W x 620D	\$929
3 - Curve no back	RAIN3CNB	1431W x 450D	\$559
4 - Curve with back	RAIN4CWB	2008W x 620D	\$1009

Shown in Warwick Dolly fabric (Citron & Mink) \$POA

SANDY TUB

ELLA TUB

• Black PU • Modern elegant styling

Base	Code	Price
1 Timber	SANDY/ELLA62T	\$239
2 Sled	ELLA/SANDY62C	\$229
3 Trestle	SANDY13C	\$339

• Scalloped arm rests

ETNA FOYER CHAIR

ONLY \$499
 ETNA01

• Internal Seat Width 460mm
 • Seat Height 500mm
 • Fabric Upholstery
 • Chrome sled base

NEW

empire 3 YEAR WARRANTY

MYSTIQUE CHAIRS

• Upholstered in velvet fabric
 • Black painted metal frame

• Upholstered in velvet fabric
 • Gold painted metal frame

VISITOR CHAIR
\$169
 LUX-MYS01B

VISITOR CHAIR
\$199
 LUX-MYS01G

empire 2 YEAR WARRANTY

Base Style	Code	Detail (all prices plastic shell)	Price
A 4 Leg	MIX61xx	Metal Frames options	\$129
B Sled*	MIX71xx	Chrome/Black/Woodgrain	\$139
C 4 Leg Timber	MIX61Tx		\$129
D Stool (630 or 760H*)	MIX630x/760x	Black or Chrome Frame	\$169
E 5 Star Base*	MIX13x	Black Nylon, gas lift and castors	\$189
F Upholstered Seat	Optional Upgrade	Fabric options: Add \$80	
G Fully Upholstered	Optional Upgrade	Ebony/Slate/Ash/Frost Add \$240	
H Arms*	Optional Upgrade	Lt.Grey/Black/White Add \$20	

MYSTIQUE STOOLS

• Fully upholstered
 • Black painted metal frame

• Fully upholstered
 • Gold painted metal frame

BAR STOOL
\$249
 LUX-MYS980B

BAR STOOL
\$249
 LUX-MYS980G

empire 2 YEAR WARRANTY

SPICER SALISBURY SALISBURY XL

• Custom fabrics available \$POA

500W x 610D SPIC From **\$269**
 570W x 620D SALB From **\$289**
 670W x 740D SALBXL From **\$379**

SHERATON

• High density foam
 • 10 frames to choose from
 • Warwick heavy commercial fabric

STOOL - FROM \$329
 SHER7504LM

FROM \$259
 SHER4LM

MALENY

• Upholstered seat and back
 • Steel tube frame • Non-stackable
 • Fabric rub tested 72,000 cycles

FROM \$289
 MALE61

NEW

SPICER STOOL SALISBURY STOOL

• Now in Warwick Gravity fabrics
 • Detailed stitch
 • High density foam seat
 • Steel or timber legs with a reinforced frame
 • Commercial grade upholstery - 50,000 rub test approved

• 650 or 750mm High

• Metal 4 Leg - Black SPIC650/750 **\$329**
 • Metal 4 Leg - Timber SPIC750 **\$349**

• Metal 4 Leg - Black SALB650/750 **\$359**
 • Metal 4 Leg - Timber SALB750 **\$369**

FINISH	ADD
5 Fabrics (Warwick Gravity) - Cloud, Denim, Navy, Slate, Steel	-
Vinyl (V) - Black	-
4 Leg Metal (4LM) - Black	-
4 Leg Metal (4LM) - Lt. Oak, Dark Walnut	\$10
4 Leg Timber (4LT) - Lt. Oak, Dark Walnut	\$70

Other bases available (\$POA): Disc, Sled, Trestle, Blade & Castors

MACKAY TUB

ONLY \$409
 MACK01

• 710W x 690D x 790H • Fully assembled
 • Available in Black leather-look (PU)

CUBE LOUNGE

SINGLE \$479
 890W - CUBE41

• 740mm deep
 • Stainless steel frame
 • Black leather look (PU)
 • Modern furniture, classic design
 • Also available in: 2 seater **\$699** 1450W - CUBE42
 3 seater **\$899** 2000W - CUBE43

CLOVELLY WRAP

ONLY \$379
 CLOVWRA

• Custom fabrics available \$POA

NEW

ARDINA

ONLY \$619
 ARDINO1

• Charcoal
 • Light Blue

• Black Powdercoat solid tube frame
 • Removable back cushion
 • Rubber button feet

• 2 Seater also available ARDINO2 **\$799**

SOUTHPORT LOUNGE

• 740mm deep
 • Black leather-look (PU)
 • Also available in 3 seater **\$969** 1820W SOUT03

SINGLE \$479
 760W - SOUT01

2 SEATER \$739
 1280W - SOUT02

PLUTO RANGE

SINGLE \$529
 870W - PLUT01

OTTOMAN \$289
 420H x 1000W x 500D PLUT04

• 730H x 760D • Fully assembled • Timeless comfort designed to impress
 • Also available in: 2 seater **\$739** 1400W - PLUT02
 3 seater **\$1009** 2000W - PLUT03

ERGOFORM



INC. ARMS
\$219
 SAVE \$100
 BLACK BASE
 ERGF22M

OPTIONAL POLISHED BASE
 ADD \$60
 ERGF22P

SAVE 37% OFF

Full ergo 3 lever mechanism
 Tilt tension control
 Adjustable arms
 Adjustable height back

empire 10 YEAR WARRANTY

FLOW



NO ARMS
\$289
 SAVE \$10
 FLOW23

OPTIONAL ADJUSTABLE ARMS
 ADD \$70
 ARMKIT29

Adj ratchet back/lumbar
 Independent tilting seat/back
 Black mesh back

empire 10 YEAR WARRANTY

THE MET



EXECUTIVE
\$399
 SAVE \$50
 ARMS INCL.
 METT12

NEW LOW PRICE

Flow & Met Testing
 Tests based on AS/NZS 4438 (Level 6)
 Height Adjustable Chairs
 259kg Static Load Test
 320,000 Cycles - Back Test
 300,000 Cycles - Seat Test
 Tests assume user weight of 140kg

Fully ergonomic
 3 lever mechanism
 Ratchet back
 Adjustable arms
 Polished aluminium base

empire 10 YEAR WARRANTY

A-TEAM



ERGONOMIC
\$319
 SAVE \$10
 ATEAM11.BK

WITH ARMS
\$399
 SAVE \$10
 ATEAM12.BK

OPTIONAL HEIGHT ADJUSTABLE ARMS
 ADD \$70

- Adjustable lumbar support
- Height adjustable arms
- High density foam
- Independent seat & back tilt
- Gas lift

Ask about upgrade to the Super-Heavy Duty Model
160kg
 ATEAM11/12HD

Name	Code	No Arms	Arms
Teamstar	TEAMS11/12	\$249	\$329
Sync A-Team in Black	ATEAMSYN11.BK/12.BK	\$259	\$319
A-Team in Black	ATEAM11.BK/12.BK	\$319*	\$399*
A-Team Ratchet	ATEAMRCH11/12	\$349	\$419
A-Team Heavy Duty	ATEAMHD11/12	\$429	\$509

*Priced in Black All Over
 Mesh back available in Black/Red/Blue/Green (\$POA)
 Seat available in many colours (\$POA)

Weight Rating 135KG
 This item has been tested by AFRDI.
 MANY Colours available POA
empire 10 YEAR WARRANTY

WING CONTRACT SEATING



STANDARD MB
\$389
 SAVE \$10
 BLACK
 WING14S.BK/BK

STANDARD HB
\$429
 SAVE \$170
 BLACK
 WING12S.BK/BK

- Medium back (no head rest)
- Synchronised mechanism with "weight balance"
- Adjustable height lumbar support
- 4 position tilt lock
- Adjustable height PU arms
- Standard castors

empire 5 YEAR WARRANTY

SHUFFLE



MED BACK
\$159
 SHUF24

Medium Back • Black mesh back
 Ideal for meetings • With arms

empire 3 YEAR WARRANTY

ABIGAIL



MED BACK
\$159
 ABIG14

Ideal meeting chair
 Single position tilt lock
 Black mesh back with black fabric seat

empire 3 YEAR WARRANTY

PEDRO



NO ARMS
\$219
 PEDR23

OPTIONAL T-ARM (FIXED HEIGHT)
 \$40 ARMKIT20

Fully Ergonomic (tilting seat & back)
 Moulded foam seat
 Black, Red, Blue, Lime & Orange

empire 5 YEAR WARRANTY

WORKMATE



ONLY
\$219
 SAVE \$30
 WORKMSHA

NEW

Synch Mech
 Modern plastic perforated backrest
 Fully adjustable arms

empire 5 YEAR WARRANTY

ZONE OPERATOR



ERGONOMIC
\$499
 SAVE \$100
 EROZ24S

- 3 position locking synchro mech
- 4 position adjustable backrest
- Height adjustable arms
- Waterfall front/seat pressure reduction

empire 5 YEAR WARRANTY

ERGOFIT



EXECUTIVE
\$549
 EFIT12M

Headrest height & angle adjustable
 Adjustable lumbar support

NEW

- High density moulded foam
- Ratchet back height adjustable
- 3D adjustable arms
- Polished aluminium base
- Synchronised mechanism - lockable in 4 positions

empire 5 YEAR WARRANTY

ERGOHUMAN



HIGH BACK
\$749
 SAVE \$220
 ERHU12S

- Adjustable arms
- Heavy duty alloy 5 star base
- Adjustable lumbar support/head rest
- Adjustable seat height/seat slider/seat depth
- Synchronised mechanism - lockable in 5 positions

empire 5 YEAR WARRANTY

LINEAR



MED BACK
\$279
 SAVE \$60
 LINE14M

ADJUSTABLE ARMS
 HEAD REST OPTION
 ADD \$36
 LINE12M/P

SYNCHRO MECHANISM

SAVE 20% OFF

Black mesh with fabric seat
 POLISHED BASE OPTION
 ADD \$60
 LINE12MP/14MP

empire 5 YEAR WARRANTY

ZEUS MEETING CHAIR



BLACK
\$299
 ZEUS14.BK

GREY
\$349
 ZEUS14.GY

Tension adjustment for chair reclining
 Full mesh, one-piece back and seat in grey (alloy base) or black (nylon base)

empire 5 YEAR WARRANTY

PROMAX Ideal Project Chair



SYNCHRO
\$309
 PMA23SY

3 LEVER
\$329
 PMA233

SLIDE/SYNCH
\$309
 PMA23SL

Smooth synchronised action
 Ergonomic independent seat and back tilt

OPTIONAL ADJUSTABLE ARMS
 ADD \$70 ARMKIT29

Synchro Model Upgrade to seat slide (RRP \$50) for FREE!

Ratchet back
 High arch base
 60mm castors
 Black mesh back

empire 5 YEAR WARRANTY

SOLIDWORX - AUSTRALIA'S TOUGHEST TRAINING CHAIR



NO ARMS
\$239
 SWRX61W.BK

WITH ARMS
\$279
 SWRX62W.BK

RIGHT TABLET
\$339
 SWRX63W.BK

Foldable arm rest and tablet
 Tablet on RHS, Size 330W x 260D

COMMON FEATURES:
 Plastic back • Stackable
 Foldable seat for nesting
 Iron tube leg and PU castor
 Simple and effective linking feature
 All components meet min of BIFMA standard
 Greenguard Certified • Approved for Government use DET 68449 SOA

Foldable arm rest

Linking Kit \$29 SWRXLINK
 STACKING TROLLEY \$209 SWRX66.BK

empire 5 YEAR WARRANTY

PU LAB STOOLS



FEATURES:
 High quality moulded PU
 Hard wearing and easy to clean

Height range: 340-580mm
 Height range: 560-820mm

Ref	Style	Code	Price
A1	Saddle	LABST02	\$159
A2	Saddle (with Drafting kit)	LABST02D	\$189
B1	Chair	LABCH23	\$199
B2	Chair (with Drafting kit)	LABCH33	\$239

empire 5 YEAR WARRANTY

26% OFF



ERGOFORM
INC. ARMS
\$239
SAVE \$87
BLACK BASE
ERGF22/M

Features:
• Tilt tension control
• Full ergo 3 lever mechanism
• Adjustable height back
• Adjustable arms
• Black fabric or Black mesh

Tested to BIFMA X5.1 – to 125kg
540,000 cycles (Tilt Mech Test)
140,000 cycles (Seat Durability Test)
60,000 cycles (Arm Durability Test)

ALSO AVAILABLE IN MESH \$219

OPTIONAL POLISHED BASE ADD \$60 ERGF22P



MAYFIELD
MED BACK
\$179
MAYF23
STANDARD ARMS ADD \$35 ARMKIT12

• Gas lift • Tilting back
• Height adj back • Black fabric



STRENGTH • DURABILITY • STABILITY

Many Empire products are officially tested and certified to internationally recognised furniture standards including BIFMA and Standards Australia.

These rigorous tests are performed by NATA accredited independent testing laboratories such as AFRDI; Advanced Furniture Testing and SGS.

CERTIFICATION = REDUCED RISK = PEACE OF MIND



EMERALD RANGE
HIGH BACK
\$199
EMER12

• Black leather look (PU) • Padded arms
• Single position tilt lock mechanism



ARLINGTON RANGE
HIGH BACK
\$299
ARLN12

CANTILEVER
\$209
ARLN46

• Knee tilt mechanism
• Multi position lock
• Black leather-look PU
• Chrome polished arms & base

• Knee tilt mechanism

• Cantilever base



MED BACK
\$199
BLACK
CONX23

Tilting back
Gas lift



HIGH BACK
\$229
CONX21

Tilting back & seat
Gas lift



EX. HIGH BACK
\$259
CONX27

Large seat
Independent seat/back tilt



ADJUSTABLE ARM ADD \$75 ARMKIT50
FIXED LOOP ARM KIT ADD \$35 ARMKIT12



DRAFTING KIT ADD \$110 DRAFT91

• High back available in Black & Navy fabrics



HIGH BACK
\$249
SAVE \$90
CHART12

• Black leather-look (PU) upholstery



MID BACK
\$229
SAVE \$70
CHART14

• Chrome base and arms
• Single position tilt lock mechanism
• HB = 630mm high
• MB = 490mm high



MID MESH
\$229
SAVE \$70
CHART14M

• Black mesh finish
• Chrome base and arms
• Single position tilt lock



23% OFF



FABRIC
\$309
NO ARMS
JEM21

OPTIONAL ARMKIT ADD \$70 ARMKIT18

SUPER-STRONG MECHANISM

• Fully ergonomic
• Independent tilting seat and back
• Steel base • Black fabric or Black Leather-Look (PU)



LEATHER-LOOK
\$359
NO ARMS
JEM21

AS SHOWN WITH ARMS \$429



BLACK FABRIC
\$429
WITH ARMS
EEXF22

• High density foam • Adjustable arms
• Extra large moulded seat/back
• Independent back & seat tilt
• Available in Black fabric



CHAIR ACCESSORIES
DON'T FORGET YOUR CHAIR MAT!

\$79 **\$99** **\$139** **\$139**

A. SMALL With anchors CHAX01
B. LARGE With anchors CHAX02
C. DIPLOMAT With anchors CHAX03
D. LARGE HARDFLOOR No anchors CHAX04

• Now 23% thicker

EXTRA THICK AVOIDS CRACKS AND DENTS



HIGH BACK
\$249
SAVE \$27
BETA12

• Slate mesh
White frame

• Single position tilt lock
• Black leather look (PU)
• "Flip-Away" arms



HIGH BACK
\$299
MARR12

• Black leather look (PU)
• Single position tilt lock



ONLY
\$579
BROAD12

• Seat height 430-530
• Back height 820H

• Super strong construction for the larger body type with extra wide seat
• Finished in very soft leather-look PU
• Polished aluminium base and arms



ONLY
\$669
BIGM12.BKLE

RATED TO 200kg

• Back height 700H
• Seat height 500-620
• Genuine leather seat & back • Tilt lock
• Fixed padded arms • Large seat
• Steel base



GIM STOOL



RED ONLY
\$29
 GIM750.RD

HALF PRICE

WHILE STOCK LASTS

- 750H x 410W x 410Dmm
- Polypropylene seat and back
- Anodised aluminium
- Suitable for indoors and outdoors
- Non-slip rubber feet
- 100% recyclable materials

1 YEAR WARRANTY

"SIDEKICK" SWIVEL STOOL



NO RING
\$109
 SAVE \$6
 NOT PICTURED SIDE01

With drafting ring (as pictured) **\$174** SIDE02

- 400mm Dia seat
- Seat height 550mm to 750mm
- Black leather look PU seat
- Chrome finish base with gas lift

3 YEAR WARRANTY

SPECTRUM CAFÉ CHAIR



ONLY
\$79
 SPEC61

10 VIBRANT COLOURS TO CHOOSE FROM

- Static seat load tested to 250kg
- Suitable for indoor or outdoor use
- Stackable
- Approved for Government use DET 68449 SOA

This item has been tested by AFRDL.

7 YEAR WARRANTY

POLY STACKER



ONLY
\$69
 UCPP481

- Strong steel frame
- Available in Black only

3 YEAR WARRANTY

STRATA STACKER



ONLY
\$89
 SSRA61

• 2 standard fabrics, Blue or Black

5 YEAR WARRANTY

BERLIN VISITOR



ONLY
\$119
 BBER44

- Cantilever
- Chrome frame
- Black Vinyl

3 YEAR WARRANTY

G20 MEETING



4 LEG
\$149
 G20LEG

- Stackable (4 high)
- Polypropylene arms
- Solid steel frame
- Black mesh back and Black (E2) fabric seat

3 YEAR WARRANTY



BAR STOOL
\$129
 SAVE \$10
 VERS81P

- Chrome frame
- 762mm seat height
- Black plastic seat and back

5 YEAR WARRANTY

VERVE RANGE



PLASTIC
\$79
 SAVE \$20
 NO ARMS
 VERS61P

Fully Assembled Options:
 • No arms (with arms SPOA)
 • Plastic • Writing tablet optional
 • Stackable/linkable • Black or Navy Blue

10 YEAR WARRANTY

*Tested to AS/NZS 4688 Fixed Height Chairs. 160kg Static Load Test. 100,000 Seat/Back Fatigue Test



FABRIC
\$139
 NO ARMS
 VERS61F

- Fabric
- Black or Red

10 YEAR WARRANTY



PLASTIC
\$129
 SAVE \$70
 VERS63P

FABRIC
\$189
 SAVE \$50
 VERS63F

VERVE STACKING TROLLEY
 10 x Fabric or 20 x Plastic
\$90 VERS66

Linking Capability

- Fabric Verve with MDF tablet
- Tablet Left VERS63xLxx
- Tablet Right VERS63xRxx

5 YEAR WARRANTY

ZOOM RANGE



NO ARMS
\$149
 BEST BUY!
 ZOOM61

WITH ARMS
\$159
 ZOOM62

SLED BASE
\$179
 ZOOM71

- Strong, chromed-steel frame
- Mesh back with Black fabric seat

3 YEAR WARRANTY

LONDON RANGE



BLACK FRAME
\$159
 BLACK FAB.
 LLON44B

CHROME
\$189
 BLACK PU
 LLON44C

- Black frame with arm pads
- Black fabric seat and back
- Chrome frame with arm pads
- Black leather-look (PU)

3 YEAR WARRANTY

SONAR CANTILEVER

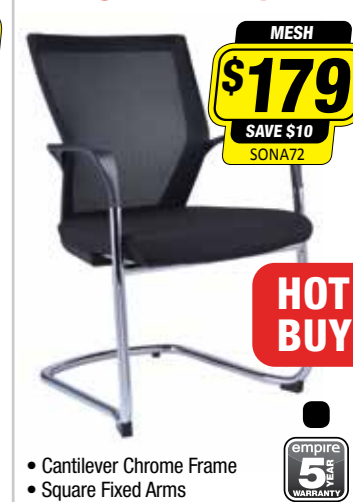

MESH
\$179
 SAVE \$10
 SONA72

HOT BUY

- Cantilever Chrome Frame
- Square Fixed Arms

5 YEAR WARRANTY

PLAY CHAIR



FROM
\$129

White with Bright Orange upholstered seat **\$169** PLAY61S

PLAY CHAIR	4 Leg*	Sled Base*	Barstool - 4-Leg, Chrome Only
Poly Seat/Back ^	PLAY61P \$129	PLAY71P \$129	PLAY81P \$349
Fabric Seat Only #	PLAY61S \$169	PLAY71S \$169	PLAY81S \$389
Fabric Seat/Back #	PLAY61F \$199	PLAY71F \$199	PLAY81F \$419

* Listed prices are for standard Poly Shell Colours on Powder Coated Frame.
 FRAME: Standard Colours - Black/White/Silver Powdercoat
 Optional - Chrome Frame **Add \$20**

^ POLY SHELL: Standard Colours - White or Charcoal
 Optional Deluxe Colours - Red, Aqua, Indigo, Daffodil & Pistachio

Standard: [Color Swatches] Deluxe: [Color Swatches] ISO14001 EMS

FABRIC: Lime Green, Tomato Red, Bright Orange, Sky Blue, Plum, Slate Grey & Black.
 Note: Upholstery is only available on White or Charcoal poly shells

\$219 PLAY71F
 Fully Upholstered On Chrome Frame.

140kg WEIGHT RATING

10 YEAR WARRANTY

The sophisticated style of the Play chair is the ultimate point of difference to others of its kind. Training, conference, classroom, healthcare, retail & cafeteria seating.

- Versatile stacking - up to 9 chairs high
- Fan-shaped
- Polypropylene seat and back
- Frame - powdercoated steel or chrome
- Frame - 4 legs or sled base
- Great lumbar support
- Poly shells can be plain or upholstered

OLIVE



NO ARMS
\$179
 OLIVE61C

No Arms
 • Black with Black frame

With Arms
 • Black with Black frame
\$219

OLIVE62C

- 4 Castors
- Stackable (6 high)
- Contoured seat and back for comfort with holes in the material to allow the body to breathe

5 YEAR WARRANTY

ANGIE VISITOR



ONLY
\$199
 ANGE44

- Chrome cantilever frame
- Matches many executive chairs
- Black leather-look (PU)

3 YEAR WARRANTY

KONFURB HARMONY



ONLY
\$329
 HARM21.WH

HARM21.BK **\$309**

- Height adjustable seat
- Contoured polypropylene moulded shell
- Superior comfort & dynamic seat movement

5 YEAR WARRANTY

PIXIE SWIVEL



ONLY
\$399
 PIXI21.GY

NEW

PIXI22.GY
 • Also available with arms **\$459**

- Fully upholstered with stitched fabric and foam

Grey

3 YEAR WARRANTY

Introducing...Lux Office

Huge range of on-trend, "Accent" pieces for Start-ups and Co-working environments

it's easier with **empire** office furniture



Saffron LUX-SAF02.xx **\$1559**



Clune LUX-CLU01.xx **\$989**



Vincent LUX-VIN03.xx **\$1649**



Danny LUX-DAN01T.xx **\$339**



Lobo LUX-LOB01.xx **\$829**



Martha LUX-MAR01.xx **\$1069**



Trevor LUX-TRE01.xx **\$749**



Zane LUX-ZAD02B.xx **\$439**



Nala Desk LUX-NALDK1160 **\$749**



Karma Coffee Table LUX-KARCTB **\$379**



Kara Side Table LUX-KARST **\$219**



Ridley Side Table LUX-RIDST400 **\$169**



Vogel Side Table LUX-VOGST450 **\$149**

Introducing... INSTINCT FLIP TABLE

FROM **\$629**
INSTFP1575B

- Tops**
- .SB
 - .RC
 - .WH
 - .BL
 - .OAK
- B**
- .SV
 - .WB

The Instinct is a beautifully designed Flip Table of Italian make. It features feet that splay outwards when the top is flipped up, allowing for much more effective storage.

- Black or White frame available
- Legs splay outwards when top is flipped up
- Lockable castors
- Italian made
- Strong structure

Top Size	Code	25mm (A)	18mm (B)
1500 x 750mm	INSTFP1575B	\$639	\$629
1800 x 750mm	INSTFP1875B	\$659	
1800 x 900mm	INSTFP1890B	\$679	



MANY Colours available
POA

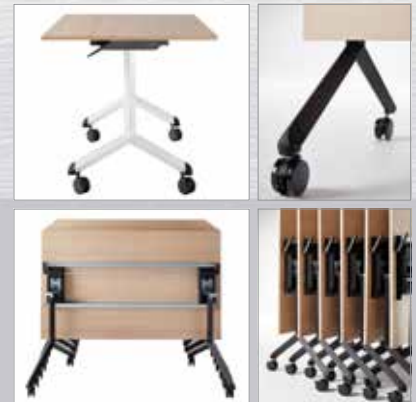

9 Huge locations throughout QLD & NSW or BUY ONLINE at empirefurniture.com.au

WOOLLOONGABBA	61 Ipswich Rd Woolloongabba	4102	P 3028 4000	gabba@empirefurniture.com.au
SYDNEY	36 Parramatta Rd (cnr Mons St) Lidcombe	2141	P 9648 0222	sydney@empirefurniture.com.au
ROCKLEA (FACTORY OUTLET)	Gate 1, 51-63 Heaton Street, Rocklea	4106	P 3272 7929	rocklea@empirefurniture.com.au
VIRGINIA	1928 Sandgate Rd Virginia	4014	P 3865 1138	virginia@empirefurniture.com.au
SOUTHPORT	180 Scarborough St Southport	4215	P 5571 1299	southport@empirefurniture.com.au
SUNSHINE COAST	Shop E, 224 Nicklin Way Warana	4575	P 5493 1365	sunshine@empirefurniture.com.au
ROCKHAMPTON	211 East St Rockhampton	4700	P 4927 7730	rockhampton@empirefurniture.com.au
MACKAY	2B Victoria St Mackay	4740	P 4944 1167	mackay@empirefurniture.com.au
TOWNSVILLE	233 Ingham Rd Garbutt	4814	P 4775 1960	townsville@empirefurniture.com.au



SCAN HERE FOR SHOWROOM DETAILS



PEFC™
PEFC/21-31-25

All prices include GST. † Prices do not include delivery, assembly, installation or rubbish removal (unless specified). \$POA We assemble at your request. Conditions apply. *Based on Recommended Retail Price. Prices valid until 03/10/21. Subject to change without notice. Some products and prices may still be available after this date. Late shoppers please enquire. E&OE. Colours reproduced are subject to the usual tolerances of the printing process. Every care has been taken to prevent printing errors. If errors have occurred we will advise you when ordering of the correct price and/or product. Savings are based on our regular retail pricing or similar products available elsewhere. Fabrics, finishes and accessories are used for photography purposes only. We will beat any written quote on equivalent product.